



Pushing Performance



People | Power | Partnership

HARTING

Han[®] M23 Circular Connectors

Contents

Page

Overview

Features	51.02
Approvals	51.02
Technical characteristics	51.03

Hoods and housings

Hoods	51.04
Bulkhead mounted housings	51.06
Cable to cable / panel feed-through housings	51.09

Inserts	51.10
---------------	--------------

Contacts	51.16
----------------	--------------

Accessories	51.17
-------------------	--------------

Assembly instructions	51.18
-----------------------------	--------------

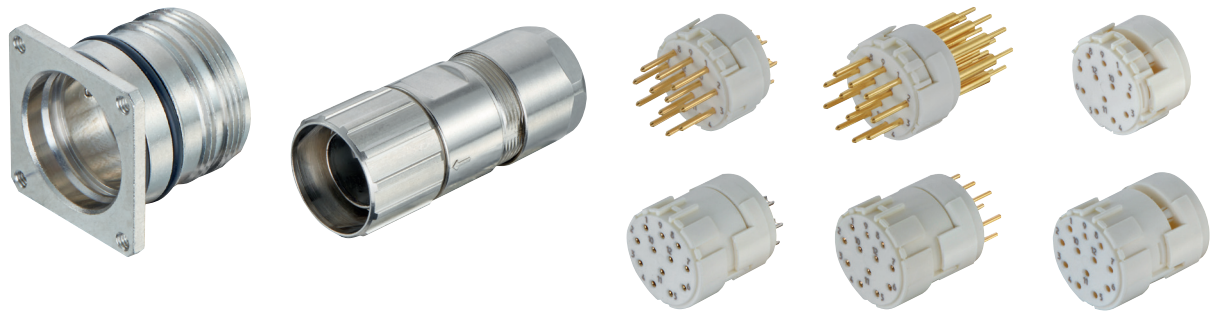

Features

- Size M23
- High contact density
- Robust hoods and housings for industrial applications
- Assembly requires no tools
- Good EMC properties
- 6 to 19 contacts
- Crimp, solder and PCB solder connections

Approvals



Note

For operating voltages over 50 volts, the connector must be used with conductive housing parts, in compliance with the safety directives in DIN VDE 410 / IEC 60364-4-41.

Connectors should not be connected or disconnected while under electrical load.

General information

It is the user's responsibility to check whether the components illustrated in this catalogue comply with different regulations from those stated in special fields of application which we are unable to foresee.

We reserve the right to modify designs in order to improve quality, keep pace with technological advancement or meet particular requirements in production. This information describes the components but should not be considered as a guarantee of certain properties.

Technical characteristics

Hoods and housings

Material	Copper zinc alloy
Surface	Nickel plated
Flat seal	Perbunan NBR
O-ring seal	Viton FPM
Limiting temperatures	-40 °C ... +125 °C
Degree of protection in locked position	IP67 / IP69K
Clamping range	3 – 17 mm

Inserts

Material	Thermoplastic polyamid							
Termination techniques	Crimp, solder, PCB solder							
Number of poles	6	7	9		12	17	19	
Number of contacts	6	7	8	1	12	17	16	3
Contact Ø	mm	2	2	1	2	1	1	1.5
Rated current	A	20	20	8	20	8	8	10
Rated voltage ¹⁾	V	300	300	200		200	160	100
Test voltage	V	2500	2500	2500		2500	1500	1500
Insulation resistance	MΩ	> 10 ¹⁰	> 10 ¹⁰	> 10 ¹⁰		> 10 ¹⁰	> 10 ⁶	> 10 ⁶
Max. contact resistance	mΩ	3	3	3		3	3	3



Derating and EMC diagram



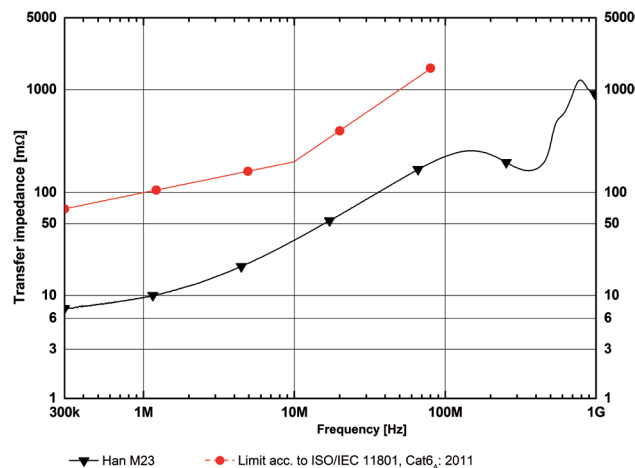
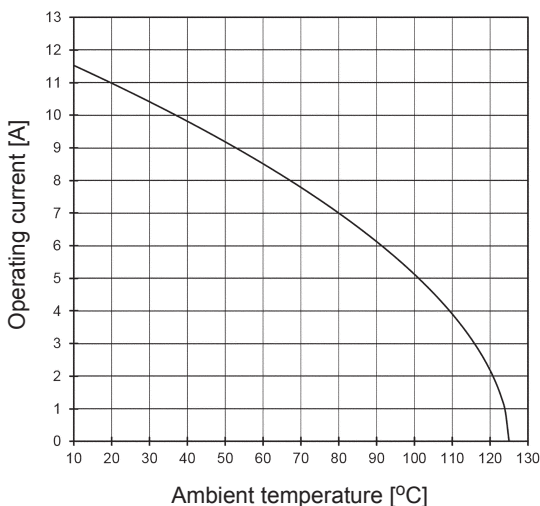

The current carrying capacity is limited by maximum temperature of materials for inserts and contacts including terminals. The current capacity-curve is valid for continuous, non-interrupted current-loaded contacts of connectors when simultaneous power on all contacts is given, without exceeding the maximum temperature.

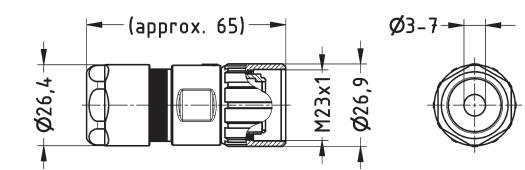

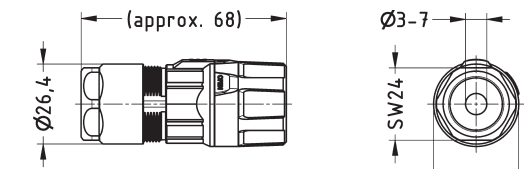
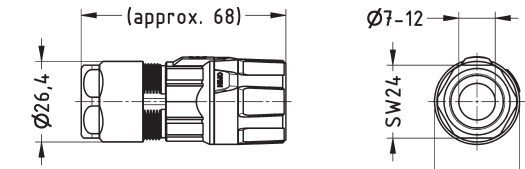
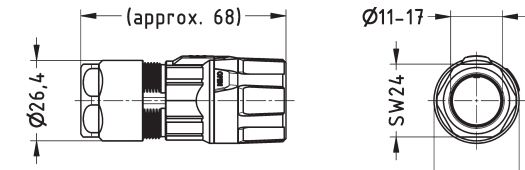
Control and testing procedures, according to DIN IEC 60512-5-2.

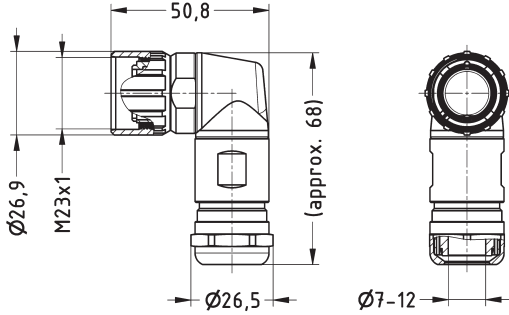

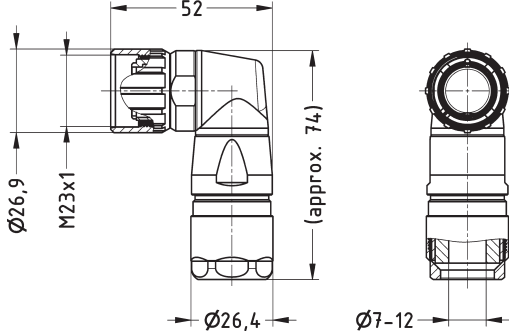

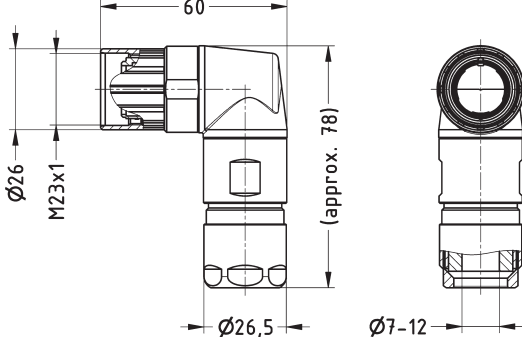

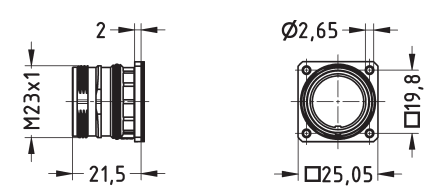

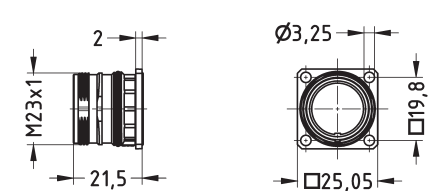
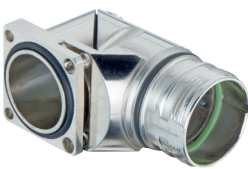
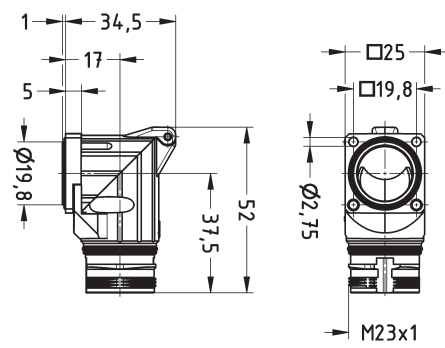
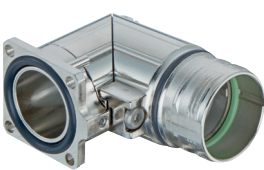
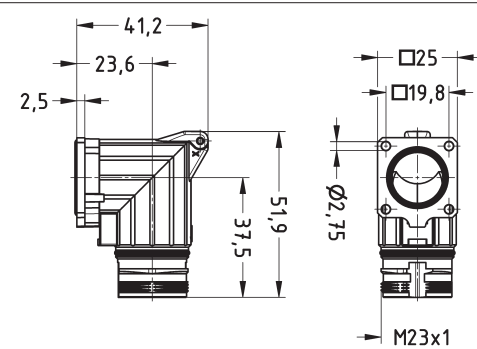
¹⁾ According to DIN VDE 0627, metallic parts which may be touched by a person and may have voltages present under fault conditions must have integral protection.

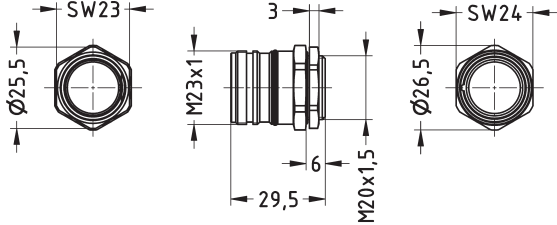

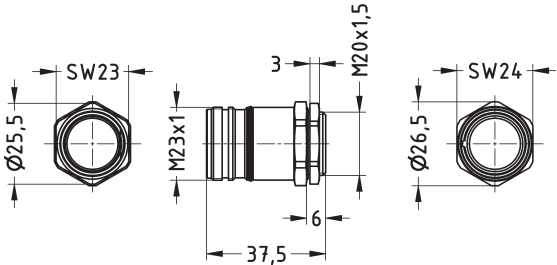

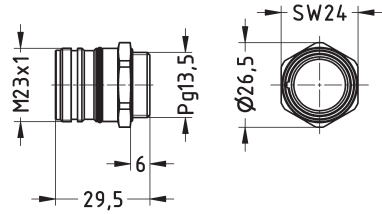

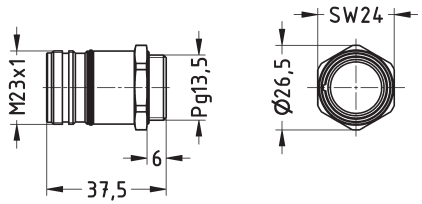
Identification	Clamping range (mm)	Part number	Drawing Dimensions in mm
<p>Hoods Incl. EMC cable gland</p> 	<p>3- 7</p>	<p>09 15 100 0401</p>	
<p>Hoods ComLock – rapid locking Incl. EMC cable gland</p>  <p>similar depiction</p>	<p>3- 7</p>	<p>09 15 100 0491</p>	
	<p>7- 12</p>	<p>09 15 100 0492</p>	
	<p>11- 17</p>	<p>09 15 100 0493</p>	

Identification	Clamping range (mm)	Part number	Drawing Dimensions in mm
<p>Angled hood Without EMC</p> 	7-12	09 15 100 0601	
<p>Angled hood Incl. EMC cable gland</p> 	7-12	09 15 100 0602	
<p>Angled hood Rotatable Incl. EMC cable gland</p> 	7-12	09 15 100 0603	

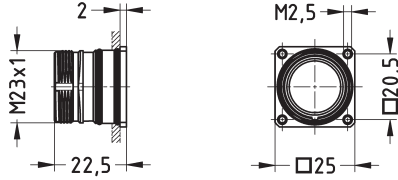
Identification	Part number	Drawing Dimensions in mm
<p>Bulkhead mounted housing Front wall assembly Flat seal (4 x 2.7 mm)</p> 	<p>09 15 100 0301</p>	 <p>Panel cut out Ø 20</p>
<p>Bulkhead mounted housing Front wall assembly O-ring seal (4 x 3.2 mm)</p> 	<p>09 15 100 0302</p>	 <p>Panel cut out Ø 20</p>
<p>Bulkhead mounted housing Angled Front wall assembly O-ring seal (4 x 2.7 mm)</p> 	<p>09 15 100 0901</p>	 <p>Panel cut out Ø 20</p>
<p>Bulkhead mounted housing Angled, rotatable Front wall assembly O-ring seal (4 x 2.7 mm)</p> 	<p>09 15 100 0902</p>	 <p>Panel cut out Ø 20</p>

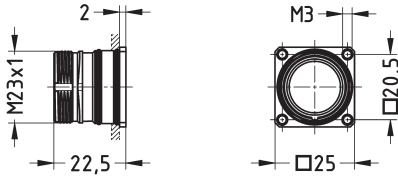

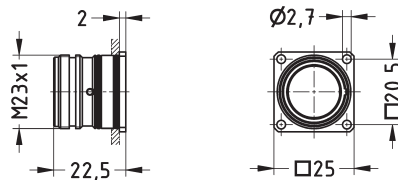

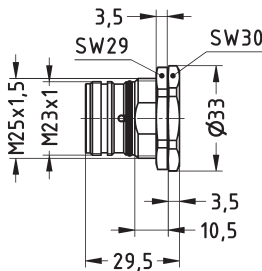
Identification	Part number	Drawing Dimensions in mm
<p>Bulkhead mounted housing Front wall assembly for male insert (M20 x 1.5)</p> 	<p>09 15 100 0363¹⁾</p>	 <p>Panel cut out Ø 20</p>
<p>Bulkhead mounted housing Front wall assembly for female insert (M20 x 1.5)</p> 	<p>09 15 100 0373¹⁾</p>	 <p>Panel cut out Ø 20</p>
<p>Bulkhead mounted housing Front wall assembly for male insert (PG 13.5)</p> 	<p>09 15 100 0364¹⁾</p>	 <p>Panel cut out Ø PG 13.5</p>
<p>Bulkhead mounted housing Front wall assembly for female insert (PG 13.5)</p> 	<p>09 15 100 0374¹⁾</p>	 <p>Panel cut out Ø PG 13.5</p>

¹⁾ Not suitable for ComLock

Identification	Part number	Drawing Dimensions in mm
<p>Bulkhead mounted housing Back wall assembly O-ring seal (4 x M2.5)</p> 	<p>09 15 100 0305</p>	 <p>Panel cut out \varnothing 20</p>
<p>Bulkhead mounted housing Back wall assembly O-ring seal (4 x M3)</p> 	<p>09 15 100 0306</p>	 <p>Panel cut out \varnothing 20</p>
<p>Bulkhead mounted housing Back wall assembly O-ring seal (4 x 2.7 mm)</p> 	<p>09 15 100 0307</p>	 <p>Panel cut out \varnothing 20</p>
<p>Bulkhead mounted housing Back wall assembly O-ring seal (M25)</p> 	<p>09 15 100 0308¹⁾</p>	 <p>Panel cut out \varnothing PG 13.5</p>

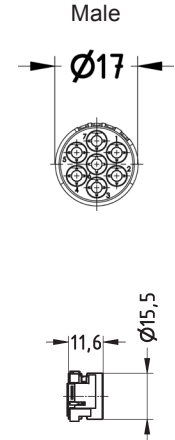
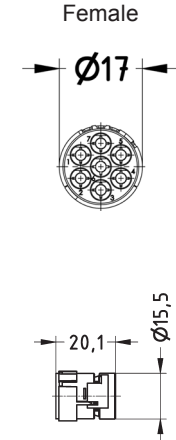
¹⁾ Not suitable for ComLock

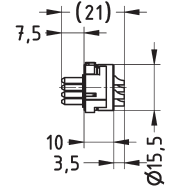
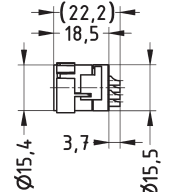

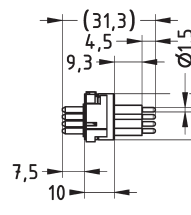
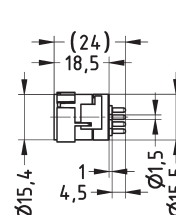
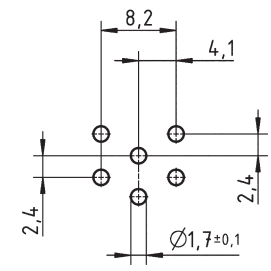
Identification	Clamping range (mm)	Part number	Drawing Dimensions in mm
Panel feed-through housings Back wall assembly With central locking (M25)	3- 7	09 15 100 0309	
	7-12	09 15 100 0310	
	11-17	09 15 100 0311	
Cable to cable housings Incl. EMC cable gland	3- 7	09 15 100 0701	
	7-12	09 15 100 0702	
	11-17	09 15 100 0703	

Identification	Number of contacts	Part number		Drawing	
		Male insert	Female insert	Dimensions in mm	
<p>Crimp termination 6 x 2 mm contacts</p> 	6	09 15 106 3001	09 15 106 3101	<p>Male</p> 	<p>Female</p> 
<p>Solder termination</p> 	6	09 15 106 2602	09 15 106 2702		
<p>PCB solder termination¹⁾</p> 	6	09 15 106 2603	09 15 106 2703		
					

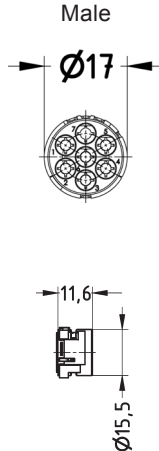
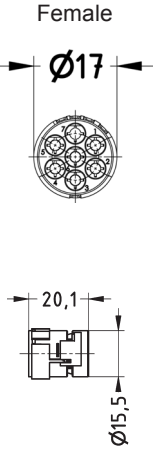
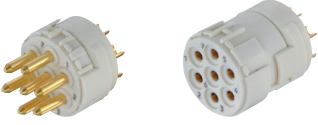
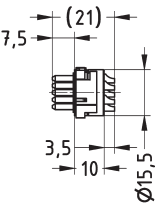
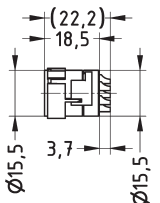
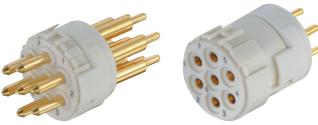
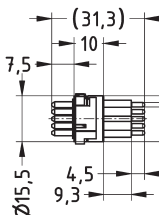
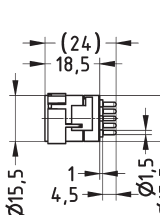
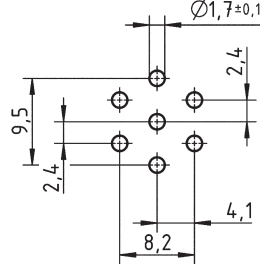

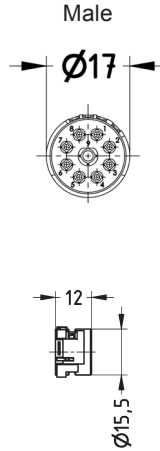
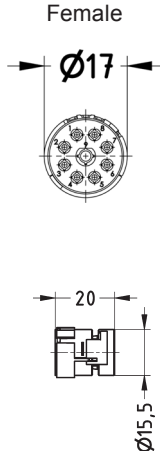

¹⁾ Only for use with bulkhead mounted housings: 09 15 100 0301, 09 15 100 0302, 09 15 100 0305, 09 15 100 0306 and 09 15 100 0307

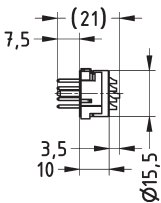
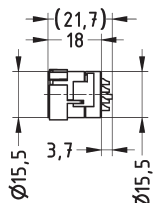
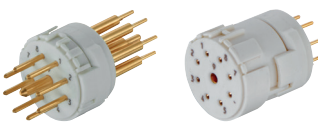
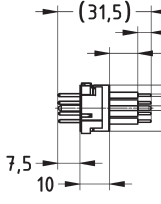
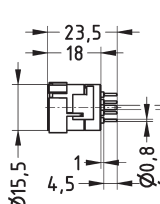
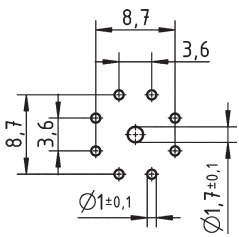
Identification	Number of contacts	Part number		Drawing	
		Male insert	Female insert	Dimensions in mm	
<p>Crimp termination 7 x 2 mm contacts</p> 	7	09 15 107 3001	09 15 107 3101	<p>Male</p> 	<p>Female</p> 
<p>Solder termination</p> 	7	09 15 107 2602	09 15 107 2702		
<p>PCB solder termination¹⁾</p> 	7	09 15 107 2603	09 15 107 2703		
					

¹⁾ Only for use with bulkhead mounted housings: 09 15 100 0301, 09 15 100 0302, 09 15 100 0305, 09 15 100 0306 and 09 15 100 0307

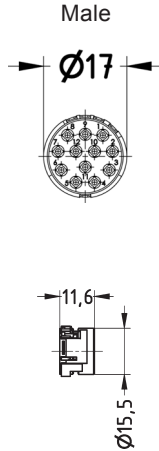
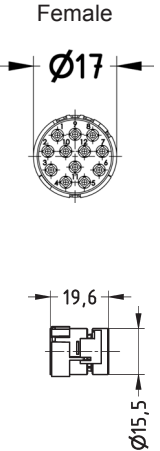
Identification	Number of contacts	Part number		Drawing	
		Male insert	Female insert	Dimensions in mm	
<p>Crimp termination 8 x 1 mm contacts 1 x 2 mm contact</p> 	9	09 15 109 3001	09 15 109 3101	<p>Male</p> 	<p>Female</p> 
<p>Solder termination</p> 	9	09 15 109 2602	09 15 109 2702		
<p>PCB solder termination¹⁾</p> 	9	09 15 109 2603	09 15 109 2703		
					

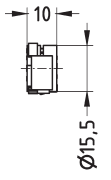
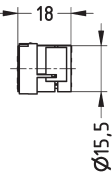

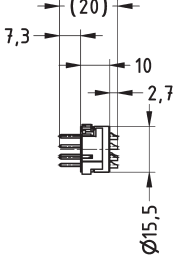
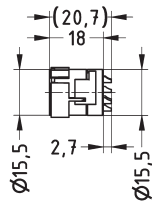
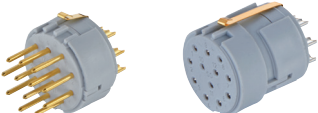
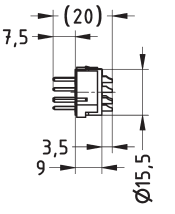
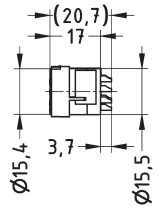
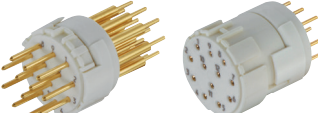
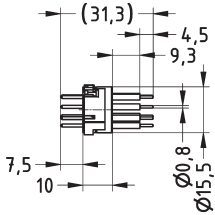
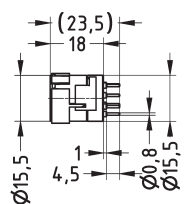
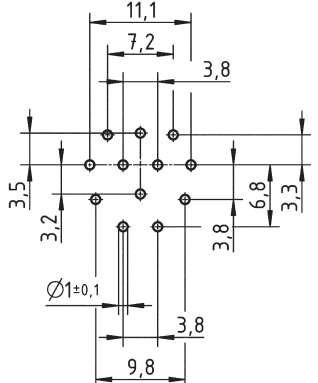
¹⁾ Only for use with bulkhead mounted housings: 09 15 100 0301, 09 15 100 0302, 09 15 100 0305, 09 15 100 0306 and 09 15 100 0307

Identification	Number of contacts	Part number		Drawing	
		Male insert	Female insert	Dimensions in mm	
<p>Crimp termination 12 x 1 mm contacts</p> 	12	09 15 112 3001	09 15 112 3101	<p>Male</p> 	<p>Female</p> 
<p>Crimp termination (with PE) 12 x 1 mm contacts</p> 	12	09 15 112 3021	09 15 112 3121		
<p>Solder termination</p> 	12	09 15 112 2602	09 15 112 2702		
<p>Solder termination (with PE)</p> 	12	09 15 112 2622	09 15 112 2722		
<p>PCB solder termination¹⁾</p> 	12	09 15 112 2603	09 15 112 2703		
					

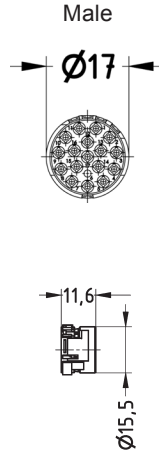
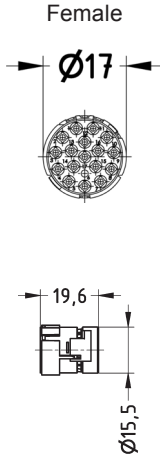
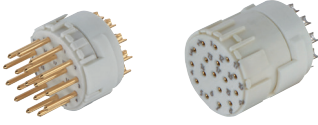
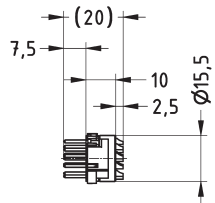
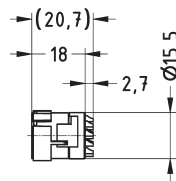
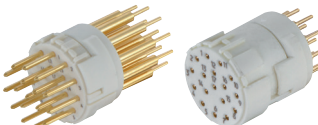
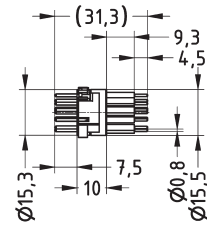
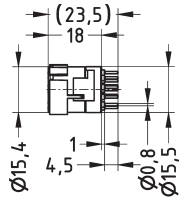
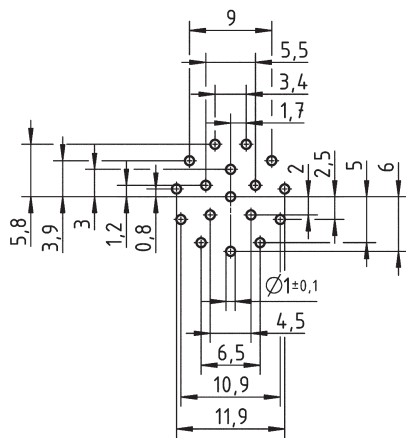

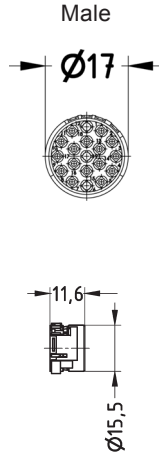
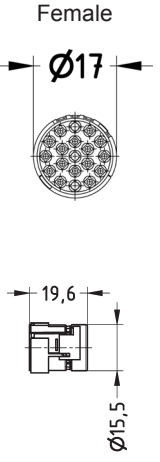

¹⁾ Only for use with bulkhead mounted housings: 09 15 100 0301, 09 15 100 0302, 09 15 100 0305, 09 15 100 0306 and 09 15 100 0307

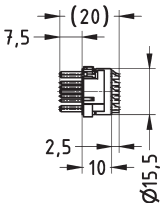
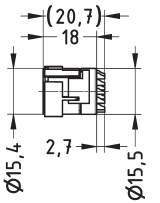
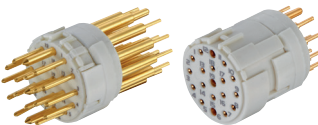
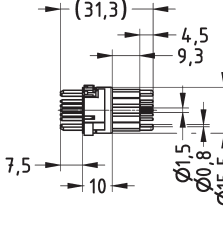
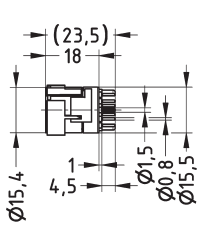
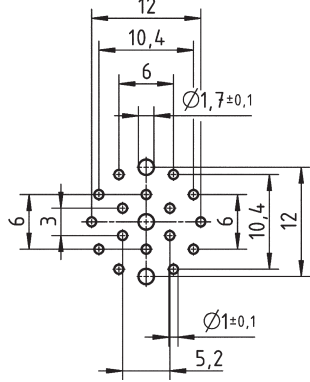



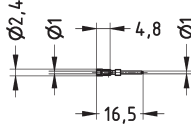
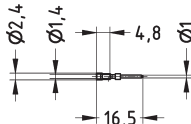
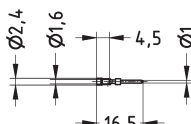
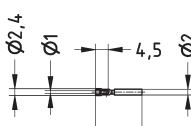
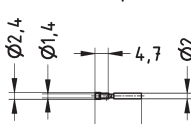
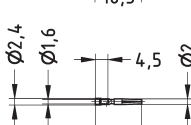

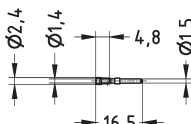
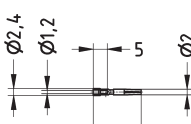
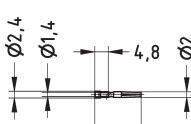
Identification	Number of contacts	Part number		Drawing	
		Male insert	Female insert	Dimensions in mm	
<p>Crimp termination 17 x 1 mm contacts</p> 	17	09 15 117 3001	09 15 117 3101	<p>Male</p> 	<p>Female</p> 
<p>Solder termination</p> 	17	09 15 117 2602	09 15 117 2702		
<p>PCB solder termination¹⁾</p> 	17	09 15 117 2603	09 15 117 2703		
					

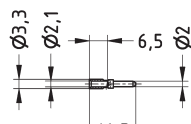
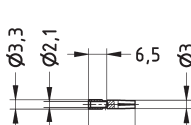
¹⁾ Only for use with bulkhead mounted housings: 09 15 100 0301, 09 15 100 0302, 09 15 100 0305, 09 15 100 0306 and 09 15 100 0307

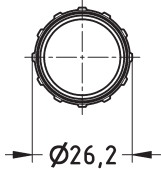
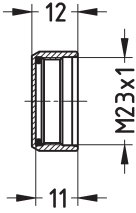
Identification	Number of contacts	Part number		Drawing	
		Male insert	Female insert	Dimensions in mm	
<p>Crimp termination 16 x 1 mm contacts 3 x 1.5 mm contacts</p> 	19	09 15 119 3001	09 15 119 3101	<p>Male</p> 	<p>Female</p> 
<p>Solder termination</p> 	19	09 15 119 2602	09 15 119 2702		
<p>PCB solder termination¹⁾</p> 	19	09 15 119 2603	09 15 119 2703		
					

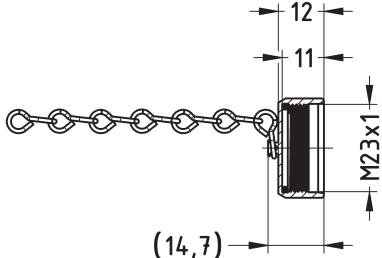
¹⁾ Only for use with bulkhead mounted housings: 09 15 100 0301, 09 15 100 0302, 09 15 100 0305, 09 15 100 0306 and 09 15 100 0307

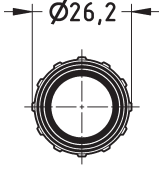
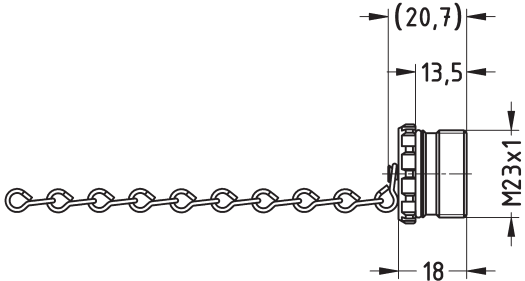
Identification	Conductor cross-section (mm ²)	Part number		Drawing Dimensions in mm		
		Male insert	Female insert			
Han® M23 crimp contacts 1 mm turned Contact surface: gold plated 	0.08 – 0.56	09 15 100 6101				
	0.14 – 1.00	09 15 100 6102				
	0.75 – 1.50	09 15 100 6103				
	0.08 – 0.56		09 15 100 6201			
	0.34 – 1.00		09 15 100 6202			
	0.75 – 1.50		09 15 100 6203			
	Han® M23 crimp contacts 1.5 mm turned Contact surface: gold plated 	0.14 – 1.00	09 15 100 6111			
		0.14 – 0.56		09 15 100 6211		
		0.34 – 1.00		09 15 100 6212		
Han® M23 crimp contacts 2 mm turned Contact surface: gold plated 	0.75 – 2.50	09 15 100 6121				
	0.75 – 2.50		09 15 100 6221			

Identification	Part number	Drawing Dimensions in mm	
<p>Screw cover for bulkhead mounted and cable to cable housings</p> 	<p>09 15 100 9101</p>		
<p>Screw cover for bulkhead mounted and cable to cable housings, with chain (70 mm)</p> 	<p>09 15 100 9102</p>		
<p>Screw cover for hoods, with chain (100 mm)</p> 	<p>09 15 100 9103</p>		
<p>Four-indent crimping tool</p> 	<p>09 99 000 0890</p>		

Four-indent crimping tool 09 99 000 0890

Conductor cross-section 0.08 to 2.5 mm²

Operating instructions

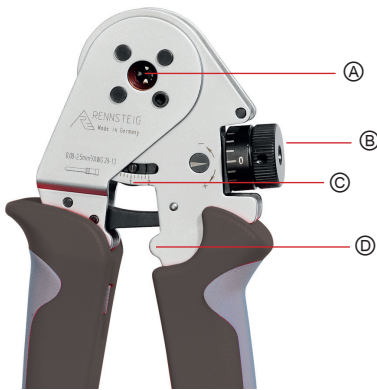

- Ⓐ Tool opening
- Ⓑ Settings dial (with 0.01 mm pitch)
- Ⓒ Settings scale (with 0.2 mm pitch)
- Ⓓ End stop

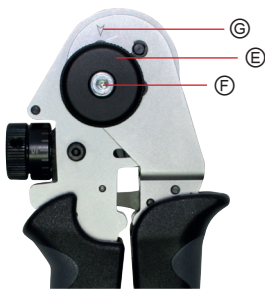

- Ⓔ Locator
- Ⓕ Hex. socket screw
- Ⓖ Latch detent (indicated by arrow)

Proper and intended use

The four-indent crimping tool (09 99 000 0890) is used for crimping Han® M23 series crimp contacts with conductor cross-sections from 0.08 mm² to 2.5 mm².

Crimping sequence

1. Refer to the "Crimp depth settings for Han® M23 crimp contacts" table (on the second following page) for the locator setting and the exact crimp depth required for the contacts you are using.
Adjust the four-indent crimping tool according to the values (refer to the section "Adjusting the locator" and "Adjusting the crimp depth").
2. Insert the contact into the tool's opening until it is in the specified crimping position.
3. Secure the contact by carefully closing the four-indent crimping tool until it reaches its first catch-lock position.
▶ The inserted contact is now secured in this position so that it cannot fall out.
4. Insert a properly stripped (refer to specifications) conductor into the crimp contact.
5. Press the crimping tool's handles together in order to crimp the contact. Press the tool's handles together until they reopen automatically.
6. Remove the crimped contact.

Operating principle of the four-indent crimping tool

NOTE

The four-indent crimping tool operates according to forced completion functionality: you must press the handles together as far as possible (until the end stop position) and then the tool will open automatically.

Adjusting the crimping depth

In order to ensure the best error-free crimp connection, the crimping depth (the gap between the crimping dies) must properly correspond to the type of contact and conductor diameter in use. You must use the proper setting for the contact! These settings are found in the table on the second following page.

Adjusting the locator

Raise the locator Ⓔ until it can be turned past the latch detent (indicated by arrow, Ⓖ). Turn the locator to the position specified in the "Crimp depth settings for Han® M23 crimp contacts" table. Then let it snap into the latch detent.

NOTE

Direction of rotation when adjusting the crimping depth

When the locator or fine-settings dial are turned clockwise, the crimping depth is reduced. When they are turned counter-clockwise, the crimping depth is increased.

Four-indent crimping tool 09 99 000 0890

Conductor cross-section 0.08 to 2.5 mm²

Operating instructions

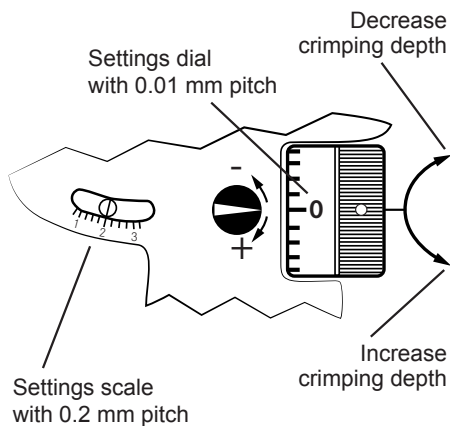

Adjustment accuracy

- 1 graduation mark on the settings dial \triangleq 0.01 mm change in the crimping depth
- 1 rotation of settings dial \triangleq 0.2 mm change in the crimping depth (This can be read on the settings scale)
- 5 rotations of settings dial \triangleq 1 mm change in the crimping depth

Testing with the go/no-go gauge

The four-indent crimping tool (09 99 000 0890) has been set at the factory. You should still make sure that you check the crimping depth regularly. For this reason, a go/no-go gauge with a 1.0 mm diameter is included with the crimping tool. Take the following steps to check that the crimping depth is correct:

1. Open the crimping tool and turn it onto the side with the settings scale.
2. Turn the settings dial until the value 1.0 mm (roughly) is shown on the settings scale
3. Now turn the settings dial so that the arrow next to the dial (at the right tool handle) is pointing to "0".
4. Close the crimping tool handles.
5. Insert the go/no-go gauge into the crimping position.
 - ▶ You must be able to insert and move the go/no-go gauge precisely between the crimping mandrels without any free room or slack.
6. If the gauge has too much room/slack or if it cannot be inserted into the crimping position, then you must make a fine adjustment using the settings dial.
 - ▶ If the deviation is above the specified tolerance of \pm 0.05 mm, please contact HARTING Service so that the tool can be serviced and recalibrated!

Maintenance and repair

Make sure that the four-indent crimping tool is clean and in good condition after each use.

1. Clean the crimping jaws and the locator.
2. Lubricate all movable parts regularly with a light all-purpose oil; this will ensure that your tool has a long service life.
3. Use retaining rings to make sure that all bolts are secured.

Four-indent crimping tool 09 99 000 0890

Conductor cross-section 0.08 to 2.5 mm²

Crimp depth settings Han® M23 crimp contacts

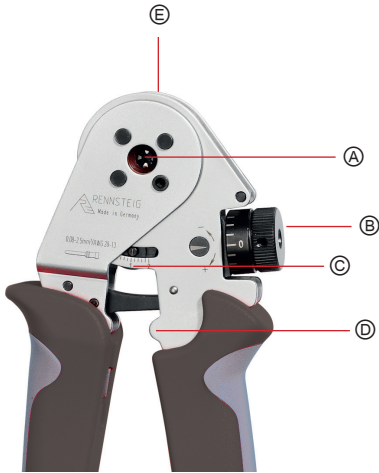

- Ⓐ Tool opening
- Ⓑ Settings dial (with 0.01 mm pitch)
- Ⓒ Settings scale (with 0.2 mm pitch)
- Ⓓ End stop
- Ⓔ Locator (on the back of the crimping tool)

Part number	Crimp contact	Conductor cross-section (mm ²)	AWG	Crimping depth	Locator position	
09 15 100 6102	Male crimp contact 1 mm	0.14	26	0.70	1	
		0.25	24	0.76		
		0.34	22	0.82		
		0.50	20	0.90		
		0.75	18	1.00		
09 15 100 6201	Female crimp contact 1 mm	0.08	28	0.75	2	
		0.14	26	0.78		
		0.25	24	0.82		
		0.34	22	0.86		
		0.56	20	0.90		
09 15 100 6202	Female crimp contact 1 mm	0.34	22	0.77	2	
		0.56	20	0.82		
		0.75	18	0.88		
		1.00	17	0.95		
		0.14	26	0.65		3
0.25	24	0.68				
0.34	22	0.72				
0.56	20	0.81				
0.75	18	0.95				
09 15 100 6111	Male crimp contact 1.5 mm	1.00	17	1.07	3	
		0.14	26	0.70		2
		0.25	24	0.73		
		0.34	22	0.77		
		0.56	20	0.85		
09 15 100 6211	Female crimp contact 1.5 mm	0.34	22	0.70	2	
		0.56	20	0.73		
		0.75	18	0.77		
		1.00	17	0.85		
		0.75	18	1.25		4
1.00	17	1.35				
1.50	16	1.45				
2.50	14	1.60				
0.75	18	1.25	5			
1.00	17	1.35				
1.50	16	1.45				
2.50	14	1.60				
09 15 100 6121	Male crimp contact 2 mm	0.08		28	0.72	1
		0.14	26	0.78		
		0.25	24	0.82		
		0.34	22	0.86		
		0.56	20	0.90		
09 15 100 6101	Male crimp contact 1 mm	0.75	18	0.80	1	
		1.00	17	0.86		
		1.50	16	0.95		
		0.75	18	0.80		2
		1.00	17	0.86		
1.50	16	0.95				

* For Han® M23 crimp contacts, the stripping length for all conductors being crimped is 4.0 mm. Permitted conductor cross-sections: 0.08 mm² to 2.5 mm².

Male

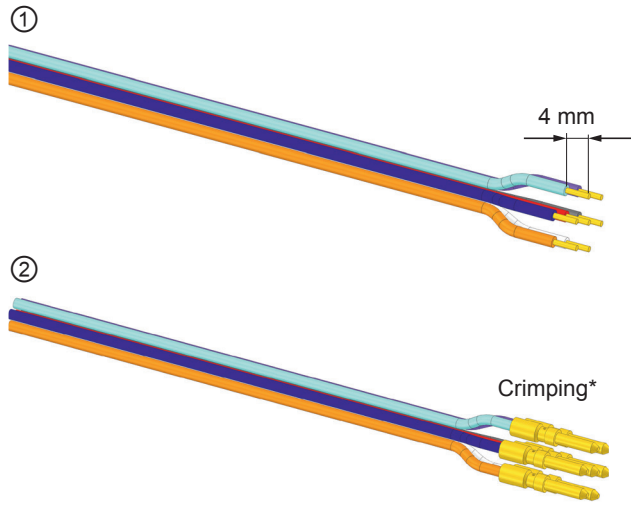

* Refer to the operating instructions for the four-indent crimping tool 09 99 000 0890, page 51.18

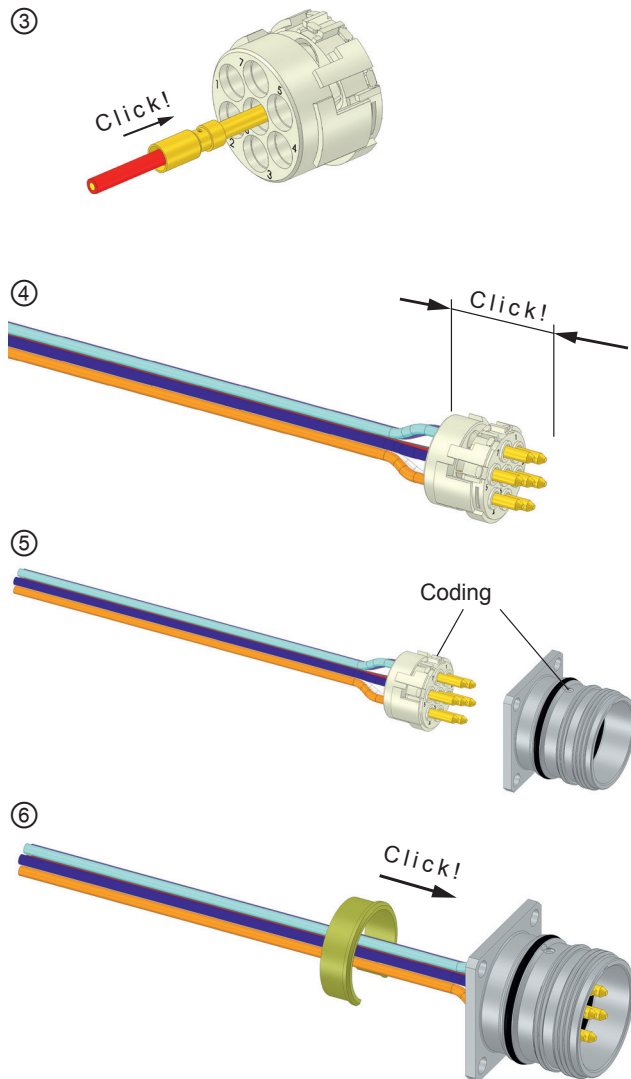

Female

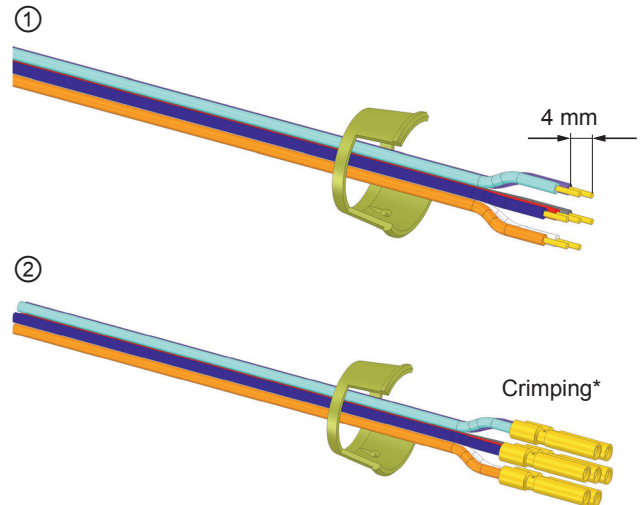

* Refer to the operating instructions for the four-indent crimping tool 09 99 000 0890, page 51.18

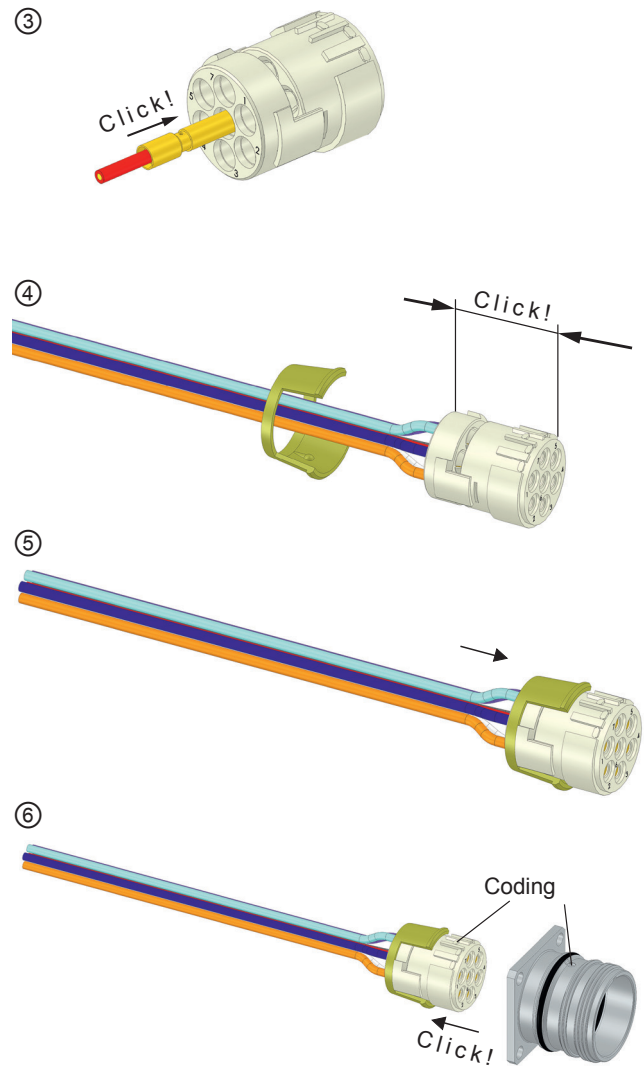

Han® M23 bulkhead mounted housings – angled

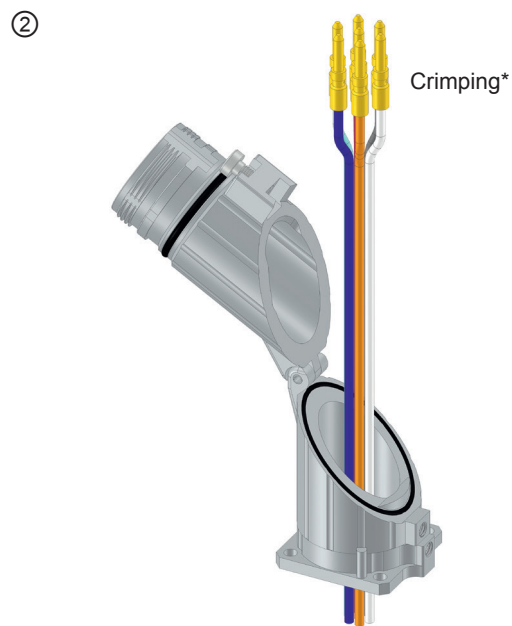
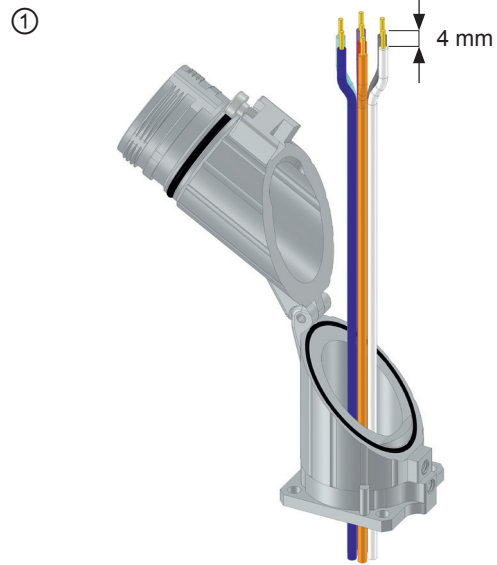

* Refer to the operating instructions for the four-indent crimping tool 09 99 000 0890, page 51.18

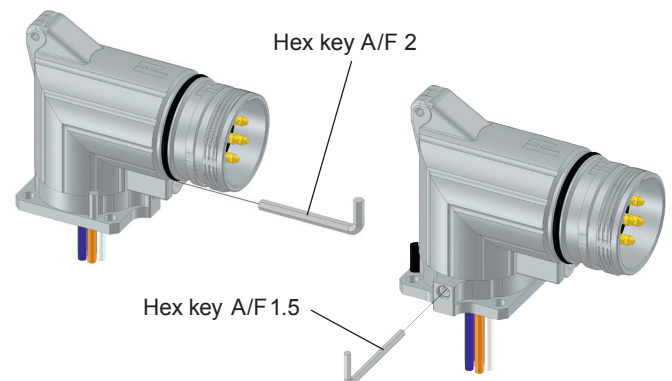
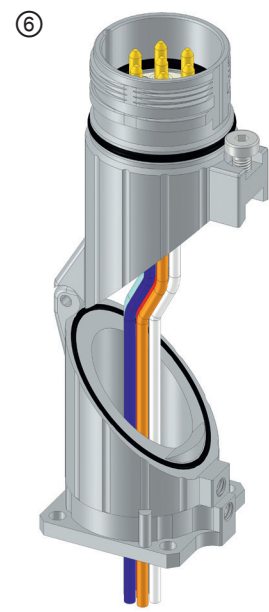
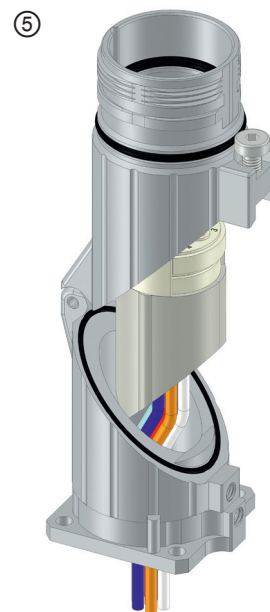
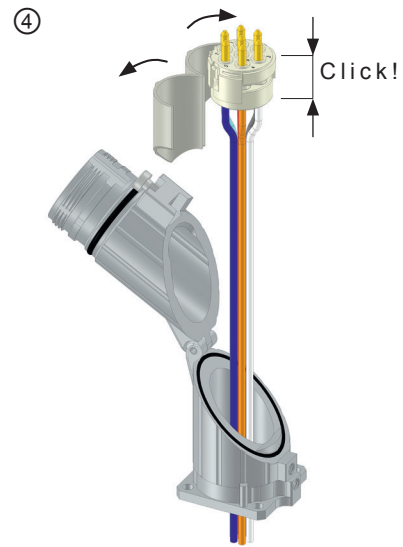
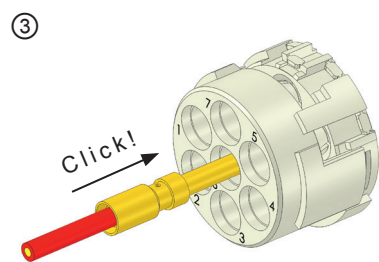

Han® M23 hoods, cable to cable / panel feed-through housings

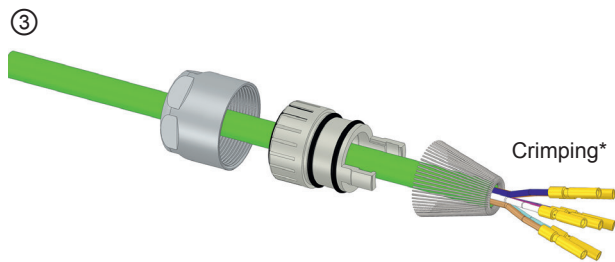
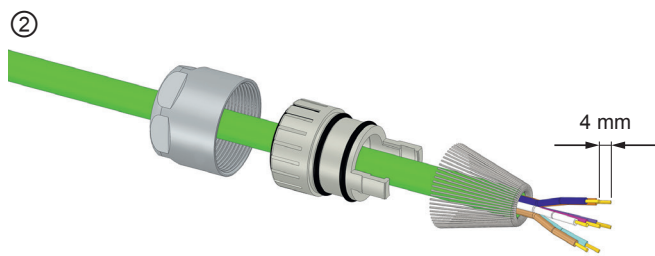
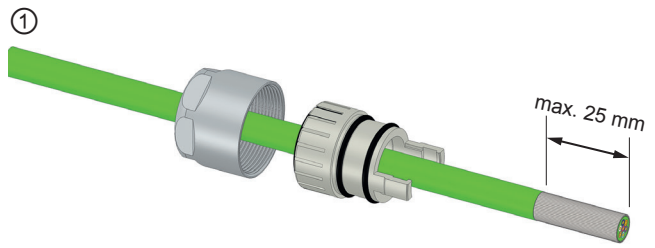

* Refer to the operating instructions for the four-indent crimping tool 09 99 000 0890, page 51.18

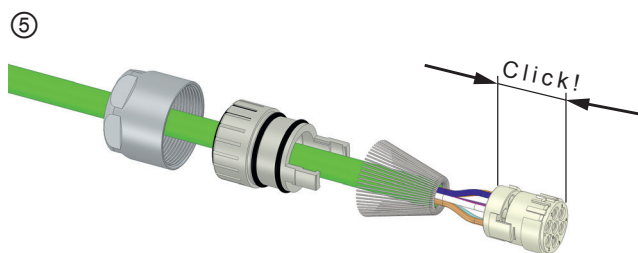
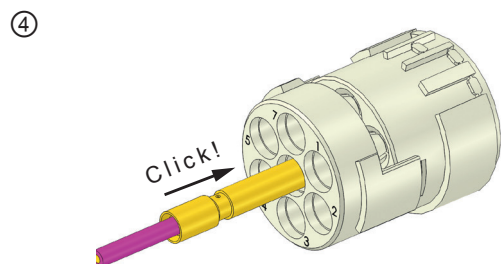

Female

Male

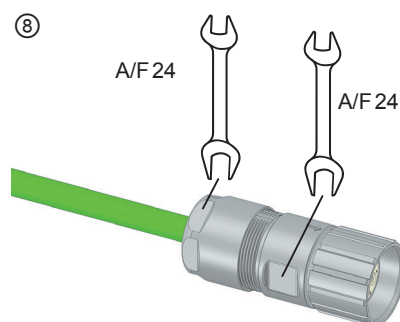
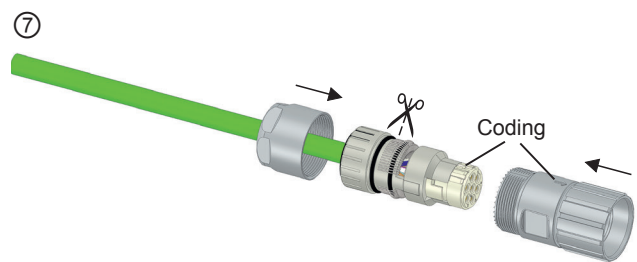
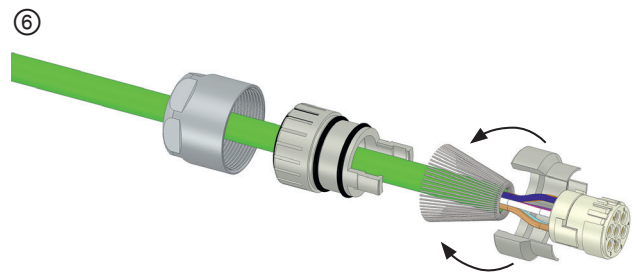
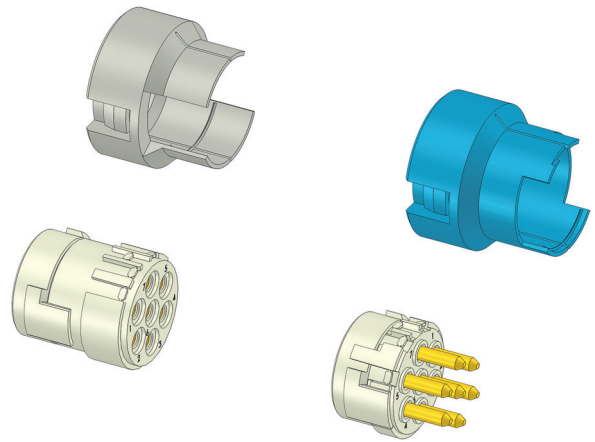

Han® M23 hoods, angled, EMC & EMC rotatable

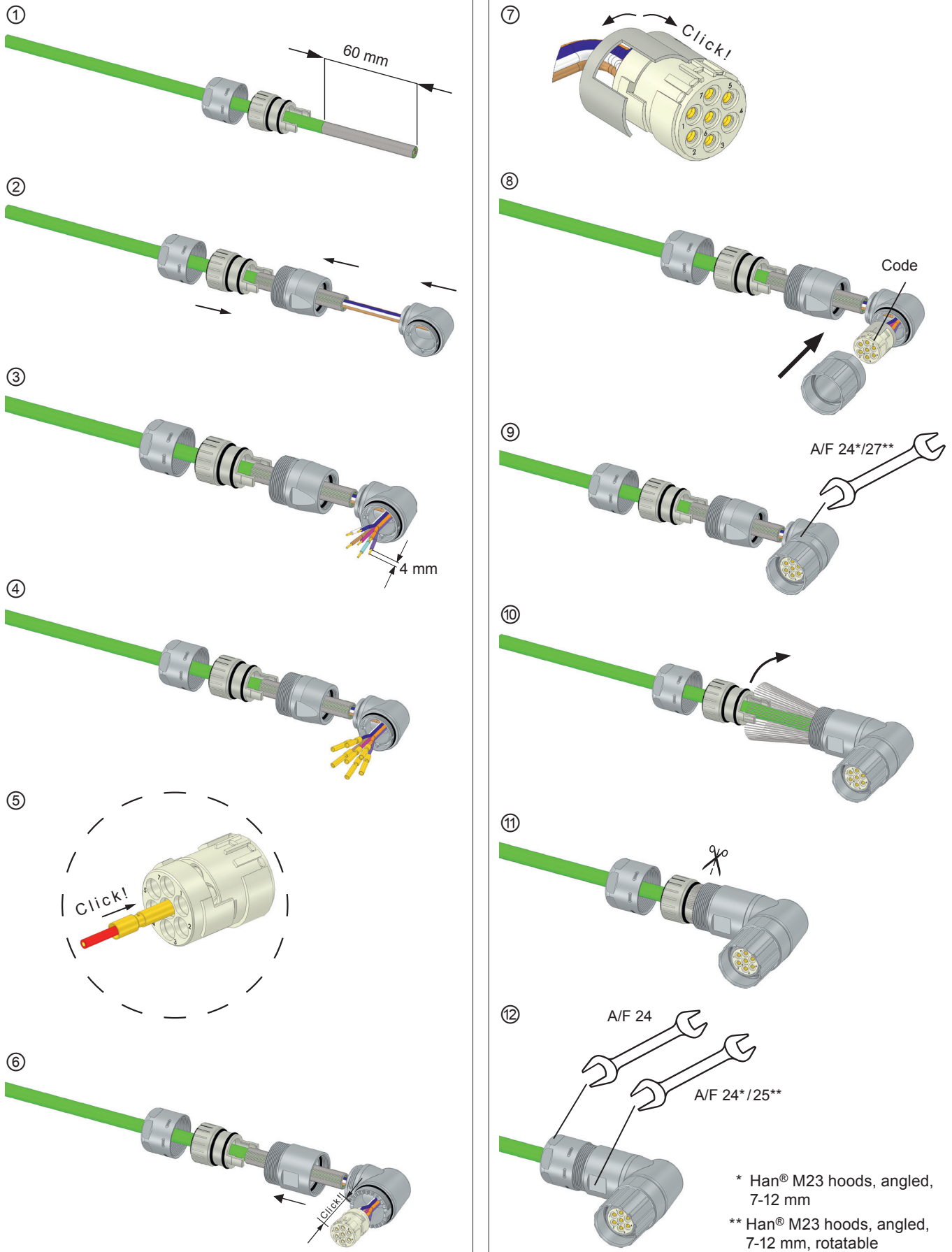

* Han® M23 hoods, angled, 7-12 mm
 ** Han® M23 hoods, angled, 7-12 mm, rotatable



Pushing Performance

HARTING.com –
the gateway to your
local website.

www.HARTING.ae
www.HARTING.at
www.HARTING.com.au
www.HARTING.be
www.HARTING.com.br
www.HARTING.ca
www.HARTING.ch
www.HARTING.com.cn
www.HARTING.cz
www.HARTING.de
www.HARTING.dk
www.HARTING.es
www.HARTING.fi
www.HARTING.fr
www.HARTING.co.uk
www.HARTING.com.hk
www.HARTING.hu
www.HARTING.co.in
www.HARTING.it
www.HARTING.co.jp
www.HARTING.co.kr
www.HARTINGbv.nl
www.HARTING.no
www.HARTING.pl
www.HARTING.pt
www.HARTING.ro
www.HARTING.ru
www.HARTING.se
www.HARTING.sg
www.HARTING.sk
www.HARTING.com.tr
www.HARTING.com.tw
www.HARTING-USA.com
www.HARTING.co.za

HARTING Technology Group

info@HARTING.com

www.HARTING.com