

Overview

KEMET's EDK Series of aluminum electrolytic surface mount capacitors are designed for high density printed circuit boards.

Applications

Typical applications include coupling, decoupling, bypass, and filtering.

Benefits

- Surface mount lead terminals
- Low profile vertical chip
- General purpose +85°C/2,000 hours



Part Number System

EDK	336	M	004		A	9B	AA
Series	Capacitance Code (pF)	Tolerance	Rated Voltage (VDC)		Electrical Parameters	Size Code	Packaging
Surface Mount Aluminum Electrolytic	First two digits represent significant figures for capacitance values. Last digit specifies the number of zeros to be added.	M = ±20%	004 = 4 6R3 = 6.3 010 = 10 016 = 16 025 = 25	035 = 35 050 = 50 063 = 63 100 = 100	A = Standard S = AEC-Q200	See Dimension Table	AA = Tape & Reel

Dimensions – Millimeters



Size Code	D		L		A/B		C		E	
	Nominal	Tolerance	Nominal	Tolerance	Nominal	Tolerance	Nominal	Tolerance	Nominal	Tolerance
9B	4	±0.5	5.4	+0.25/-0.1	4.3	±0.2	5.5	Maximum	1.8	±0.2
9D	5	±0.5	5.4	+0.25/-0.1	5.3	±0.2	6.5	Maximum	2.2	±0.2
9G	6.3	±0.5	5.4	+0.25/-0.1	6.6	±0.2	7.8	Maximum	2.6	±0.2
9H	6.3	±0.5	7.7	±0.3	6.6	±0.2	7.8	Maximum	2.6	±0.2
9M	8	±0.5	10.2	±0.3	8.3	±0.2	10	Maximum	3.4	±0.2
9P	10	±0.5	10.2	±0.3	10.3	±0.2	13	Maximum	3.5	±0.2

Size Code	F		G		P		W	
	Nominal	Tolerance	Nominal	Tolerance	Nominal	Tolerance	Nominal	Tolerance
9B	0.3	Maximum	0.35	+0.15/-0.2	1.0	±0.2	0.65	±0.1
9D	0.3	Maximum	0.35	+0.15/-0.2	1.5	±0.2	0.65	±0.1
9G	0.3	Maximum	0.35	+0.15/-0.2	1.8	±0.2	0.65	±0.1
9H	0.3	Maximum	0.35	+0.15/-0.2	1.8	±0.2	0.65	±0.1
9M	0.3	Maximum	0.70	±0.2	3.1	±0.2	0.9	±0.2
9P	0.3	Maximum	0.70	±0.2	4.6	±0.2	0.9	±0.2

Environmental Compliance

As an environmentally conscious company, KEMET is working continuously with improvements concerning the environmental effects of both our capacitors and their production. In Europe (RoHS Directive) and in some other geographical areas like China, legislation has been put in place to prevent the use of some hazardous materials, such as lead (Pb), in electronic equipment. All products in this catalog are produced to help our customers' obligations to guarantee their products and fulfill these legislative requirements. The only material of concern in our products has been lead (Pb), which has been removed from all designs to fulfill the requirement of containing less than 0.1% of lead in any homogeneous material. KEMET will closely follow any changes in legislation world wide and makes any necessary changes in its products, whenever needed.

Some customer segments such as medical, military and automotive electronics may still require the use of lead in electrode coatings. To clarify the situation and distinguish products from each other, a special symbol is used on the packaging labels for RoHS compatible capacitors.

Because of customer requirements, there may appear additional markings such as LF = Lead Free or LFW = Lead Free Wires on the label.

Performance Characteristics

Item	Performance Characteristics
Capacitance Range	1 – 1,500 μ F
Rated Voltage	4 – 100 VDC
Operating Temperature	-40°C to +85°C
Capacitance Tolerance	\pm 20% at 120 Hz/20°C
Life Test	2,000 hours (see conditions in Test Method & Performance)
Leakage Current	$I \leq 0.01 CV$ or 3 μ A, whichever is greater C = rated capacitance (μ F), V = rated voltage (VDC). Voltage applied for 2 minutes at 20°C.

Impedance Z Characteristics at 120 Hz

Rated Voltage (VDC)	4	6.3	10	16	25	35	50	63	100
Z (-25°C)/Z (20°C)	7	4	3	2	2	2	2	2	2
Z (-40°C)/Z (20°C)	15	8	6	4	4	3	3	3	3

Compensation Factor of Ripple Current (RC) vs. Frequency

Rated Voltage (VDC)	60 Hz	120 Hz	1 kHz	10 kHz
Coefficient	0.80	1.00	1.15	1.25

Test Method & Performance

Conditions	Load Life Test	Shelf Life Test
Temperature	85°C	85°C
Test Duration	2,000 hours	1,000 hours
Ripple Current	Maximum ripple current specified at 120 Hz 85°C	No ripple current applied
Voltage	The sum of DC voltage and the peak AC voltage must not exceed the rated voltage of the capacitor.	No voltage applied
Performance	The following specifications will be satisfied when the capacitor is restored to 20°C:	
Capacitance Change	Within ±20% of the initial value	
Dissipation Factor	Does not exceed 200% of the specified value	
Leakage Current	Does not exceed specified value	

Shelf Life

The capacitance, ESR and impedance of a capacitor will not change significantly after extended storage periods, however the leakage current will very slowly increase.

KEMET's E-series aluminum electrolytic capacitors should not be stored in high temperatures or where there is a high level of humidity.

The suitable storage condition for KEMET's E-series aluminum electrolytic capacitors is +5 to +35°C and less than 75% in relative humidity.

KEMET's E-series aluminum electrolytic capacitors should not be stored in damp conditions such as water, saltwater spray or oil spray.

KEMET's E-series aluminum electrolytic capacitors should not be stored in an environment full of hazardous gas (hydrogen sulphide, sulphurous acid gas, nitrous acid, chlorine gas, ammonium, etc.)

KEMET's E-series aluminum electrolytic capacitors should not be stored under exposure to ozone, ultraviolet rays or radiation.

If a capacitor has been stored for more than 18 months under these conditions and it shows increased leakage current, then a treatment by voltage application is recommended.

Re-age (Reforming) Procedure

Apply the rated voltage to the capacitor at room temperature for a period of one hour, or until the leakage current has fallen to a steady value below the specified limit. During re-aging a maximum charging current of twice the specified leakage current or 5 mA (whichever is greater) is suggested.

Table 1 – Ratings & Part Number Reference

VDC	VDC Surge Voltage	Rated Capacitance 120 Hz 20°C (μF)	Case Size D x L (mm)	DF 120 Hz 20°C ($\tan \delta$ %)	RC 120 Hz 85°C (mA)	LC 20°C 2 Minutes (μA)	Part Number
4	5	33	4 x 5.4	35	26	3.0	EDK336M004(1)9BAA
4	5	47	4 x 5.4	35	34	3.0	EDK476M004(1)9BAA
4	5	100	5 x 5.4	35	61	4.0	EDK107M004(1)9DAA
4	5	220	6.3 x 5.4	35	82	8.8	EDK227M004(1)9GAA
4	5	330	6.3 x 5.4	35	80	13.2	EDK337M004(1)9GAA
4	5	470	6.3 x 7.7	35	200	18.8	EDK477M004(1)9HAA
6.3	8	22	4 x 5.4	26	20	3.0	EDK226M6R3(1)9BAA
6.3	8	33	4 x 5.4	26	22	3.0	EDK336M6R3(1)9BAA
6.3	8	47	4 x 5.4	26	36	3.0	EDK476M6R3(1)9BAA
6.3	8	47	5 x 5.4	26	46	3.0	EDK476M6R3(1)9DAA
6.3	8	100	5 x 5.4	26	47	6.3	EDK107M6R3(1)9DAA
6.3	8	100	6.3 x 5.4	26	71	6.3	EDK107M6R3(1)9GAA
6.3	8	220	6.3 x 5.4	35	74	13.9	EDK227M6R3(1)9GAA
6.3	8	220	6.3 x 7.7	35	235	13.9	EDK227M6R3(1)9HAA
6.3	8	330	6.3 x 7.7	35	280	20.8	EDK337M6R3(1)9HAA
6.3	8	470	8 x 10.2	35	380	29.6	EDK477M6R3(1)9MAA
6.3	8	1000	8 x 10.2	35	500	63.0	EDK108M6R3(1)9MAA
6.3	8	1000	10 x 10.2	35	700	63.0	EDK108M6R3(1)9PAA
6.3	8	1500	10 x 10.2	35	750	94.5	EDK158M6R3(1)9PAA
10	13	22	4 x 5.4	30	28	3.0	EDK226M010(1)9BAA
10	13	33	4 x 5.4	30	29	3.3	EDK336M010(1)9BAA
10	13	33	5 x 5.4	20	43	3.3	EDK336M010(1)9DAA
10	13	47	5 x 5.4	30	43	4.7	EDK476M010(1)9DAA
10	13	100	6.3 x 5.4	26	70	10.0	EDK107M010(1)9GAA
10	13	220	6.3 x 7.7	26	250	22.0	EDK227M010(1)9HAA
10	13	330	8 x 10.2	26	330	33.0	EDK337M010(1)9MAA
10	13	470	8 x 10.2	26	390	47.0	EDK477M010(1)9MAA
10	13	470	10 x 10.2	26	400	47.0	EDK477M010(1)9PAA
10	13	1000	10 x 10.2	26	580	100.0	EDK108M010(1)9PAA
16	20	4.7	4 x 5.4	16	20	3.0	EDK475M016(1)9BAA
16	20	10	4 x 5.4	16	28	3.0	EDK106M016(1)9BAA
16	20	22	4 x 5.4	26	28	3.5	EDK226M016(1)9BAA
16	20	22	5 x 5.4	16	39	3.5	EDK226M016(1)9DAA
16	20	33	5 x 5.4	26	45	5.3	EDK336M016(1)9DAA
16	20	33	6.3 x 5.4	16	66	5.3	EDK336M016(1)9GAA
16	20	47	5 x 5.4	16	45	7.5	EDK476M016(1)9DAA
16	20	47	6.3 x 5.4	16	70	7.5	EDK476M016(1)9GAA
16	20	100	6.3 x 5.4	20	70	16.0	EDK107M016(1)9GAA
16	20	100	6.3 x 7.7	20	85	16.0	EDK107M016(1)9HAA
16	20	220	6.3 x 7.7	20	162	35.2	EDK227M016(1)9HAA
16	20	220	8 x 10.2	20	280	35.2	EDK227M016(1)9MAA
16	20	330	8 x 10.2	20	320	52.8	EDK337M016(1)9MAA
16	20	330	10 x 10.2	20	380	52.8	EDK337M016(1)9PAA
16	20	470	8 x 10.2	20	350	75.2	EDK477M016(1)9MAA
16	20	470	10 x 10.2	20	420	75.2	EDK477M016(1)9PAA
25	32	4.7	4 x 5.4	14	22	3.0	EDK475M025(1)9BAA
25	32	10	4 x 5.4	20	24	3.0	EDK106M025(1)9BAA
25	32	10	5 x 5.4	14	28	3.0	EDK106M025(1)9DAA
25	32	22	5 x 5.4	20	35	5.5	EDK226M025(1)9DAA
25	32	22	6.3 x 5.4	14	55	5.5	EDK226M025(1)9GAA
25	32	33	5 x 5.4	20	42	8.3	EDK336M025(1)9DAA
25	32	33	6.3 x 5.4	14	65	8.3	EDK336M025(1)9GAA
25	32	47	6.3 x 5.4	20	70	11.8	EDK476M025(1)9GAA
25	32	47	6.3 x 7.7	16	96	11.8	EDK476M025(1)9HAA
25	32	100	6.3 x 7.7	16	143	25.0	EDK107M025(1)9HAA
25	32	100	8 x 10.2	16	180	25.0	EDK107M025(1)9MAA
25	32	220	8 x 10.2	16	230	55.0	EDK227M025(1)9MAA
25	32	220	10 x 10.2	16	310	55.0	EDK227M025(1)9PAA
25	32	330	8 x 10.2	16	270	82.5	EDK337M025(1)9MAA
VDC	VDC Surge	Rated Capacitance	Case Size	DF	RC	LC	Part Number

(1) Insert Electrical Parameters code. See Part Number System for available options.

Table 1 – Ratings & Part Number Reference cont'd

VDC	VDC Surge Voltage	Rated Capacitance 120 Hz 20°C (µF)	Case Size D x L (mm)	DF 120 Hz 20°C (tan δ %)	RC 120 Hz 85°C (mA)	LC 20°C 2 Minutes (µA)	Part Number
25	32	330	10 x 10.2	16	340	82.5	EDK337M025(1)9PAA
25	32	470	10 x 10.2	16	380	117.5	EDK477M025(1)9PAA
35	44	2.2	4 x 5.4	12	8	3.0	EDK225M035(1)9BAA
35	44	3.3	4 x 5.4	12	10	3.0	EDK335M035(1)9BAA
35	44	4.7	4 x 5.4	12	22	3.0	EDK475M035(1)9BAA
35	44	10	4 x 5.4	16	24	3.5	EDK106M035(1)9BAA
35	44	10	5 x 5.4	12	30	3.5	EDK106M035(1)9DAA
35	44	22	5 x 5.4	16	36	7.7	EDK226M035(1)9DAA
35	44	22	6.3 x 5.4	12	60	7.7	EDK226M035(1)9GAA
35	44	33	6.3 x 5.4	16	60	11.6	EDK336M035(1)9GAA
35	44	33	6.3 x 7.7	14	130	11.6	EDK336M035(1)9HAA
35	44	47	6.3 x 5.4	16	70	16.5	EDK476M035(1)9GAA
35	44	47	6.3 x 7.7	14	165	16.5	EDK476M035(1)9HAA
35	44	100	6.3 x 7.7	14	140	35.0	EDK107M035(1)9HAA
35	44	100	8 x 10.2	14	180	35.0	EDK107M035(1)9MAA
35	44	220	8 x 10.2	14	200	77.0	EDK227M035(1)9MAA
35	44	220	10 x 10.2	14	310	77.0	EDK227M035(1)9PAA
35	44	330	10 x 10.2	14	350	115.5	EDK337M035(1)9PAA
50	63	1	4 x 5.4	12	10	3.0	EDK105M050(1)9BAA
50	63	2.2	4 x 5.4	12	16	3.0	EDK225M050(1)9BAA
50	63	3.3	4 x 5.4	12	16	3.0	EDK335M050(1)9BAA
50	63	4.7	4 x 5.4	14	18	3.0	EDK475M050(1)9BAA
50	63	4.7	5 x 5.4	12	23	3.0	EDK475M050(1)9DAA
50	63	10	5 x 5.4	14	27	5.0	EDK106M050(1)9DAA
50	63	10	6.3 x 5.4	12	35	5.0	EDK106M050(1)9GAA
50	63	22	6.3 x 5.4	14	40	11.0	EDK226M050(1)9GAA
50	63	22	6.3 x 7.7	12	90	11.0	EDK226M050(1)9HAA
50	63	33	6.3 x 7.7	12	90	16.5	EDK336M050(1)9HAA
50	63	33	8 x 10.2	12	120	16.5	EDK336M050(1)9MAA
50	63	47	6.3 x 7.7	12	90	23.5	EDK476M050(1)9HAA
50	63	47	8 x 10.2	12	120	23.5	EDK476M050(1)9MAA
50	63	100	8 x 10.2	12	200	50.0	EDK107M050(1)9MAA
50	63	100	10 x 10.2	12	250	50.0	EDK107M050(1)9PAA
50	63	220	10 x 10.2	12	300	110.0	EDK227M050(1)9PAA
63	79	4.7	6.3 x 5.4	18	20	3.0	EDK475M063(1)9GAA
63	79	10	6.3 x 5.4	18	20	6.3	EDK106M063(1)9GAA
63	79	22	6.3 x 7.7	18	40	13.9	EDK226M063(1)9HAA
63	79	22	8 x 10.2	18	40	13.9	EDK226M063(1)9MAA
63	79	33	8 x 10.2	18	45	20.8	EDK336M063(1)9MAA
63	79	47	8 x 10.2	18	45	29.6	EDK476M063(1)9MAA
63	79	100	10 x 10.2	18	60	63.0	EDK107M063(1)9PAA
100	125	3.3	6.3 x 7.7	18	50	3.3	EDK335M100(1)9HAA
100	125	4.7	6.3 x 7.7	18	50	4.7	EDK475M100(1)9HAA
100	125	10	6.3 x 7.7	18	50	10.0	EDK106M100(1)9HAA
100	125	10	8 x 10.2	18	55	10.0	EDK106M100(1)9MAA
100	125	22	8 x 10.2	18	55	22.0	EDK226M100(1)9MAA
100	125	22	10 x 10.2	18	85	22.0	EDK226M100(1)9PAA
100	125	33	10 x 10.2	18	90	33.0	EDK336M100(1)9PAA
VDC	VDC Surge	Rated Capacitance	Case Size	DF	RC	LC	Part Number

(1) Insert Electrical Parameters code. See Part Number System for available options.

Mounting Positions (Safety Vent)

In operation, electrolytic capacitors will always conduct a leakage current which causes electrolysis. The oxygen produced by electrolysis will regenerate the dielectric layer but, at the same time, the hydrogen released may cause the internal pressure of the capacitor to increase. The overpressure vent (safety vent) ensures that the gas can escape when the pressure reaches a certain value. All mounting positions must allow the safety vent to work properly.

Installing

- A general principle is that lower-use temperatures result in a longer, useful life of the capacitor. For this reason, it should be ensured that electrolytic capacitors are placed away from heat-emitting components. Adequate space should be allowed between components for cooling air to circulate, particularly when high ripple current loads are applied. In any case, the maximum category temperature must not be exceeded.
- Do not deform the case of capacitors or use capacitors with a deformed case.
- Verify that the connections of the capacitors are able to insert on the board without excessive mechanical force.
- If the capacitors require mounting through additional means, the recommended mounting accessories shall be used.
- Verify the correct polarization of the capacitor on the board.
- Verify that the space around the pressure relief device is according to the following guideline:

Case Diameter	Space Around Safety Vent
≤ 16 mm	> 2 mm
> 16 to ≤ 40 mm	> 3 mm
> 40 mm	> 5 mm

It is recommended that capacitors always be mounted with the safety device uppermost or in the upper part of the capacitor.

- If the capacitors are stored for a long time, the leakage current must be verified. If the leakage current is superior to the value listed in this catalog, the capacitors must be reformed. In this case, they can be reformed by application of the rated voltage through a series resistor approximately 1 kΩ for capacitors with $V_R \leq 160$ V (5 W resistor) and 10 kΩ for the other rated voltages.
- In the case of capacitors connected in series, a suitable voltage sharing must be used.
 In the case of balancing resistors, the approximate resistance value can be calculated as: $R = 60/C$

KEMET recommends, nevertheless, to ensure that the voltage across each capacitor does not exceed its rated voltage.

Application and Operation Guidelines

Electrical Ratings:

Capacitance (ESC)



Simplified equivalent circuit diagram of an electrolytic capacitor

The capacitive component of the equivalent series circuit (Equivalent Series Capacitance ESC) is determined by applying an alternate voltage of ≤ 0.5 V at a frequency of 120 or 100 Hz and 20°C (IEC 384-1, 384-4).

Temperature Dependence of the Capacitance

Capacitance of an electrolytic capacitor depends upon temperature: with decreasing temperature the viscosity of the electrolyte increases, thereby reducing its conductivity.

Capacitance will decrease if temperature decreases. Furthermore, temperature drifts cause armature dilatation and, therefore, capacitance changes (up to 20% depending on the series considered, from 0 to 80°C). This phenomenon is more evident for electrolytic capacitors than for other types.

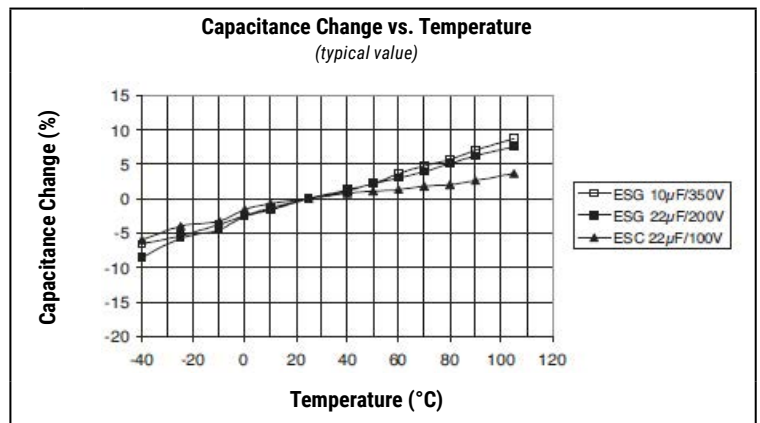

Frequency Dependence of the Capacitance

Effective capacitance value is derived from the impedance curve, as long as impedance is still in the range where the capacitance component is dominant.

$$C = \frac{1}{2\pi fZ}$$

C = Capacitance (F)
 f = Frequency (Hz)
 Z = Impedance (Ω)

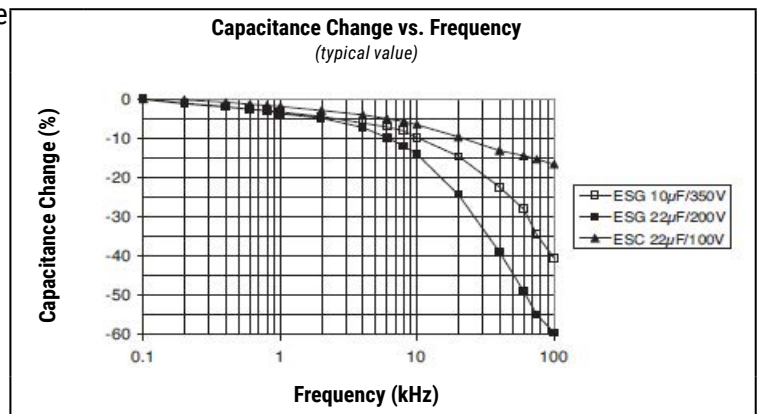

Dissipation Factor $\tan \delta$ (DF)

Dissipation Factor $\tan \delta$ is the ratio between the active and reactive power for a sinusoidal waveform voltage. It can be thought of as a measurement of the gap between an actual and ideal capacitor.

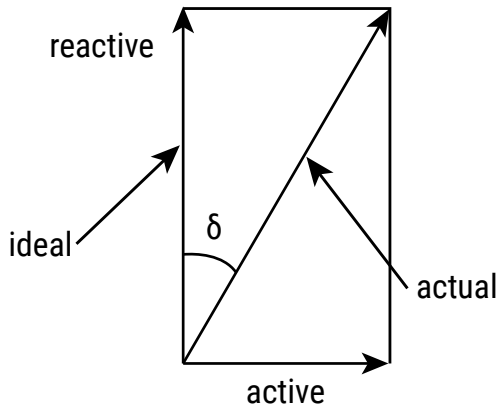

Tan δ is measured with the same set-up used for the series capacitance ESC.

$\tan \delta = \omega \times \text{ESC} \times \text{ESR}$ where:

ESC = Equivalent Series Capacitance

ESR = Equivalent Series Resistance

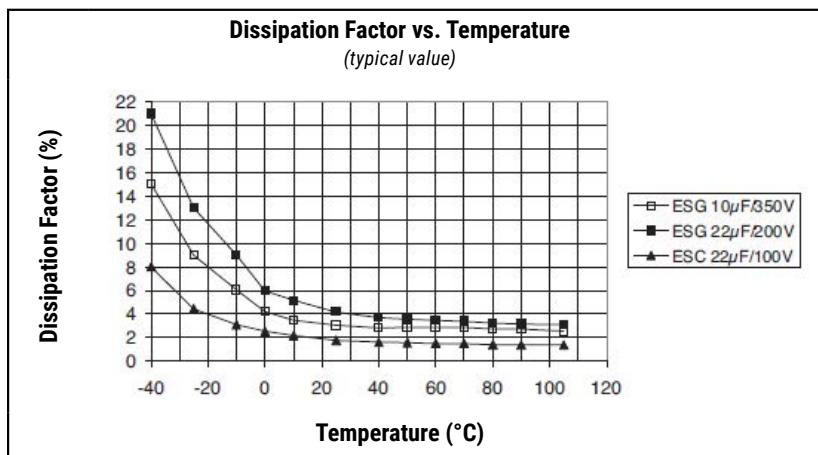
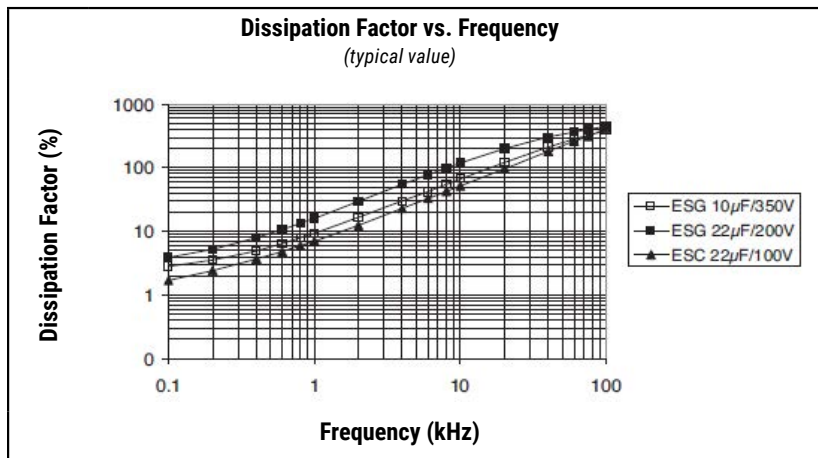

Equivalent Series Inductance (ESL)

Equivalent Series Inductance or Self Inductance results from the terminal configuration and internal design of the capacitor.

Capacitor Equivalent Internal Circuit

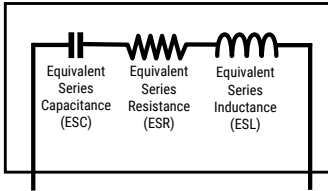

Equivalent Series Resistance (ESR)

Equivalent Series Resistance is the resistive component of the equivalent series circuit. ESR value depends on frequency and temperature and is related to the $\tan \delta$ by the following equation:

$$ESR = \frac{\tan \delta}{2\pi f ESC}$$

ESR = Equivalent Series Resistance (Ω)
 $\tan \delta$ = Dissipation Factor
 ESC = Equivalent Series Capacitance (F)
 f = Frequency (Hz)

Tolerance limits of the rated capacitance must be taken into account when calculating this value.

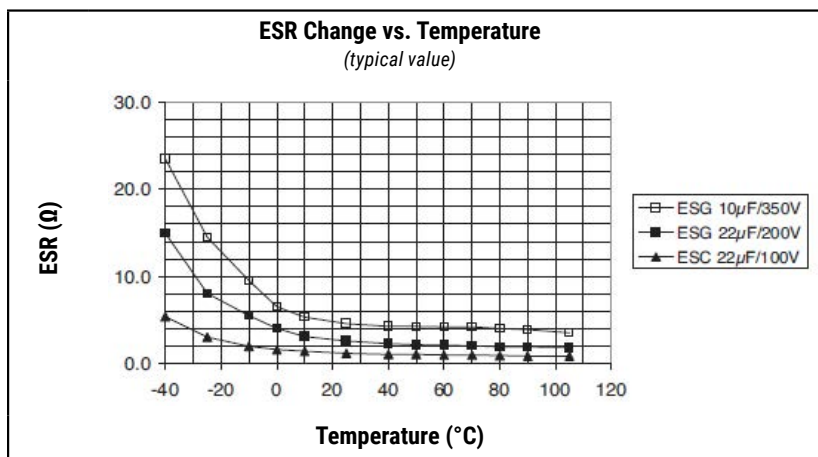
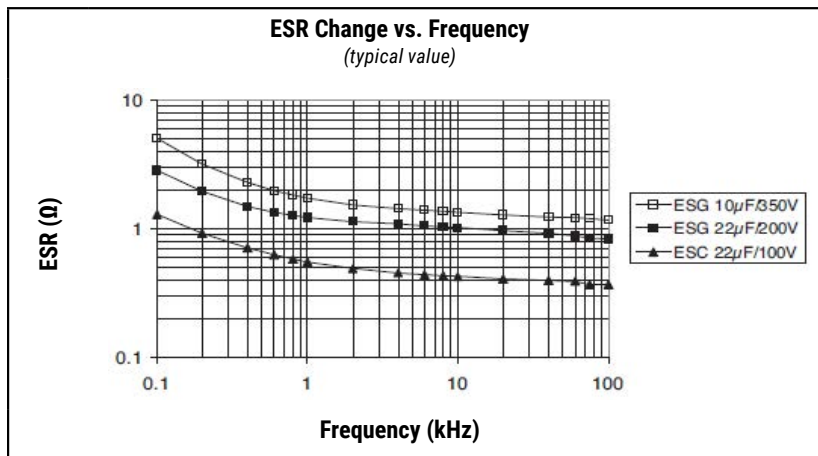

Impedance (Z)

Impedance of an electrolytic capacitor results from a circuit formed by the following individual equivalent series components:

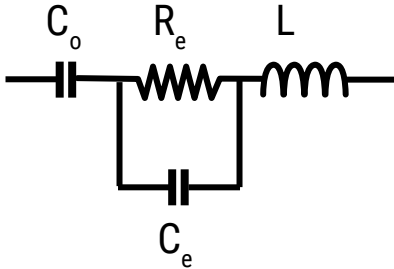

C_o = Aluminum oxide capacitance (surface and thickness of the dielectric)

R_e = Resistance of electrolyte and paper mixture (other resistances not depending on the frequency are not considered: tabs, plates, etc.)

C_e = Electrolyte soaked paper capacitance

L = Inductive reactance of the capacitor winding and terminals

Impedance of an electrolytic capacitor is not a constant quantity that retains its value under all conditions; it changes depending on frequency and temperature.

Impedance as a function of frequency (sinusoidal waveform) for a certain temperature can be represented as follows:

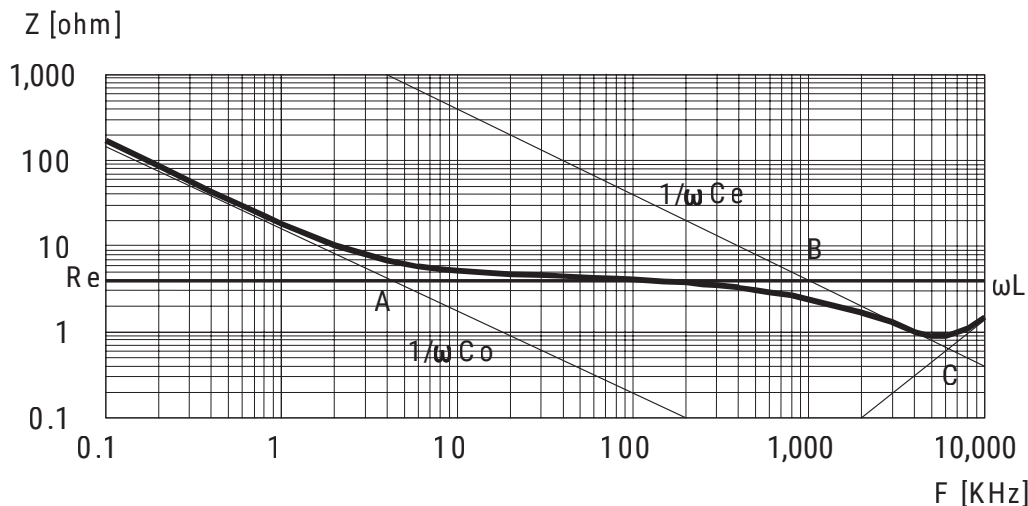

- Capacitive reactance predominates at low frequencies
- With increasing frequency, capacitive reactance $X_c = 1/\omega C_o$ decreases until it reaches the order of magnitude of electrolyte resistance R_e (A)
- At even higher frequencies, resistance of the electrolyte predominates: $Z = R_e$ (A - B)
- When the capacitor's resonance frequency is reached (ω_0), capacitive and inductive reactance mutually cancel each other $1/\omega C_e = \omega L$, $\omega_0 = C\sqrt{1/LC_e}$
- Above this frequency, inductive reactance of the winding and its terminals ($X_L = Z = \omega L$) becomes effective and leads to an increase in impedance

Generally speaking, it can be estimated that $C_e \approx 0.01 C_o$.

Impedance (Z) cont'd

Impedance as a function of frequency (sinusoidal waveform) for different temperature values can be represented as follows (typical values):

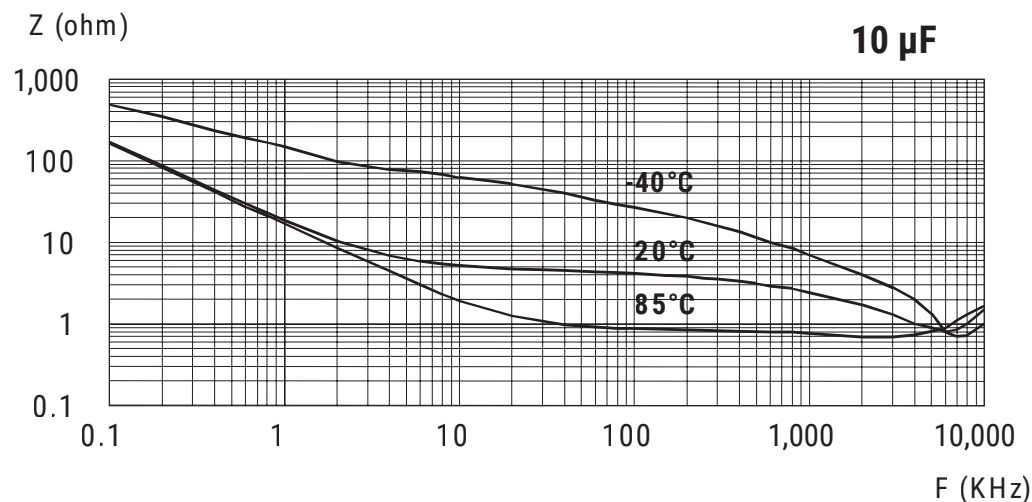

R_e is the most temperature-dependent component of an electrolytic capacitor equivalent circuit. Electrolyte resistivity will decrease if temperature rises.

In order to obtain a low impedance value throughout the temperature range, R_e must be as little as possible. However, R_e values that are too low indicate a very aggressive electrolyte, resulting in a shorter life of the electrolytic capacitor at high temperatures. A compromise must be reached.

Leakage Current (LC)

Due to the aluminum oxide layer that serves as a dielectric, a small current will continue to flow even after a DC voltage has been applied for long periods. This current is called leakage current.

A high leakage current flows after applying voltage to the capacitor then decreases in a few minutes, e.g., after prolonged storage without any applied voltage. In the course of continuous operation, the leakage current will decrease and reach an almost constant value.

After a voltage-free storage the oxide layer may deteriorate, especially at high temperature. Since there are no leakage currents to transport oxygen ions to the anode, the oxide layer is not regenerated. The result is that a higher than normal leakage current will flow when voltage is applied after prolonged storage.

Leakage Current (LC) cont'd

As the oxide layer is regenerated in use, the leakage current will gradually decrease to its normal level.

The relationship between the leakage current and voltage applied at constant temperature can be shown schematically as follows:

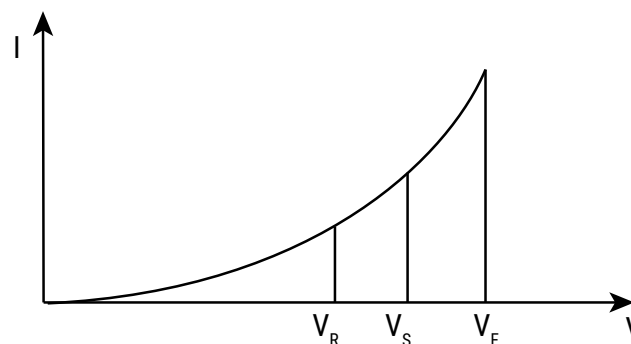

Where:

V_F = **Forming voltage**

If this level is exceeded, a large quantity of heat and gas will be generated and the capacitor could be damaged.

V_R = **Rated Voltage**

This level represents the top of the linear part of the curve.

V_S = **Surge voltage**

This lies between V_R and V_F . The capacitor can be subjected to V_S for short periods only.

Electrolytic capacitors are subjected to a reforming process before acceptance testing. The purpose of this preconditioning is to ensure that the same initial conditions are maintained when comparing different products.

Ripple Current (RC)

The maximum ripple current value depends on:

- Ambient temperature
- Surface area of the capacitor (heat dissipation area)
- tan δ or ESR
- Frequency

The capacitor's life depends on the thermal stress.

Frequency Dependence of the Ripple Current

ESR and, thus, the tan δ depend on the frequency of the applied voltage. This indicates that the allowed ripple current is also a function of the frequency.

Temperature Dependence of the Ripple Current

The data sheet specifies maximum ripple current at the upper category temperature for each capacitor.

Expected Life Calculation

Expected life depends on operating temperature according to the following formula: $L = L_0 \times 2^{(T_0 - T)/10}$

Where:

L: Expected life

L_0 : Load life at maximum permissible operating temperature

T: Actual operating temperature

T_0 : Maximum permissible operating temperature

This formula is applicable between 40°C and T_0 .

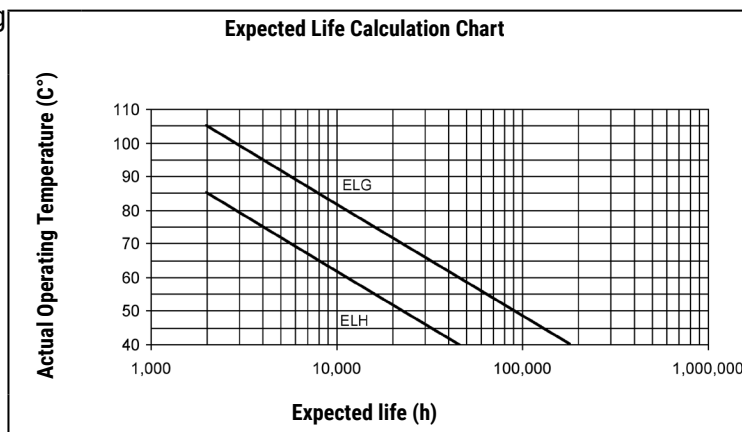

Packaging Quantities

Size Code	Diameter (mm)	Length (mm)	Reel Quantity	Box Quantity (4 Reels per box)
9B	4	5.4	2,000	10,000
9D	5	5.4	1,000	10,000
9G	6.3	5.4	1,000	10,000
9H	6.3	7.7	1,000	10,000
9M	8	10.2	500	4,000
9P	10	10.2	500	4,000

Standard Marking for Surface Mount Types

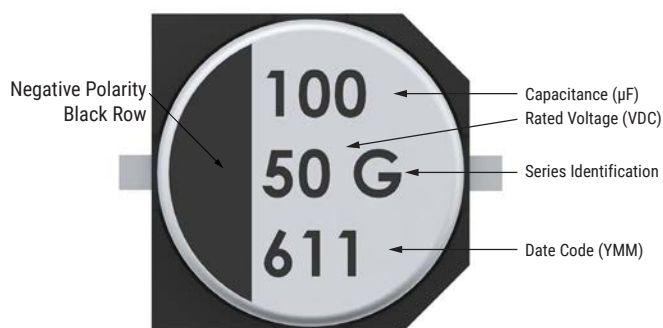

Note: 6.3 V rated voltage shall be marked as 6 V, but 6.3 V shall be assured.

*Y = Year

Code	0	1	2	3	4	5	6	7	8	9
Year	2010	2011	2012	2013	2014	2015	2016	2017	2018	2019

M = Month

Code	1	2	3	4	5	6	7	8	9	A	B	C
Month	1	2	3	4	5	6	7	8	9	10	11	12

M = Manufacturing internal code

Construction



Soldering Process

The soldering conditions should be within the specified conditions below:

Do not dip the capacitors body into the melted solder. Flux should only be applied to the capacitors terminals

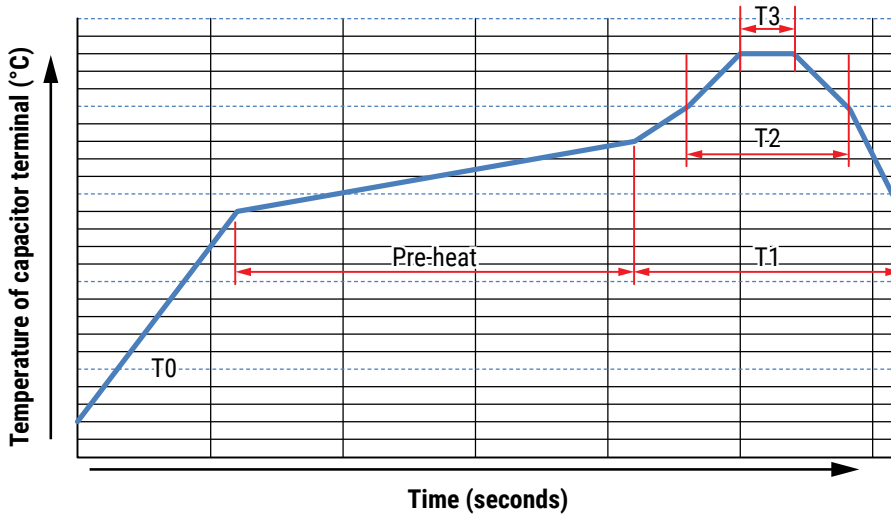

Vapour heat transfer systems are not recommended.

The system should be thermal, such as infra-red radiation or hot blast

Observe the soldering conditions as shown below.

Do not exceed these limits and avoid repeated reflowing

Reflow Soldering

	Temperature (°C)	Maximum Time (Seconds)
T0	20 to 140	60
Pre-heat	140 to 180	150
T1	180 to 140	100
T2	> 200	60
T3	230	20

Lead Free Reflow Soldering

	Temperature (°C)	Maximum Time (Seconds)
T0	20 to 160	60
Pre-heat	160 to 190	120
T1	190 to 180	90
T2	> 220	60

Lead Free Reflow Soldering cont'd.

T3	Size	Temperature (°C)	Maximum Time (Seconds)
	Φ4 ~ Φ5 (4 - 50 V)	250	10
		260	5
	Φ6.3 ~ Φ10 (4 - 50 V)	250	5
	Φ4 ~ Φ10 (63 - 100 V)	250	5

T3	Size	Temperature (°C)	Maximum Time (Seconds)
	Φ4 ~ Φ5 (4 - 50 V)	250	10
		260	5
	Φ6.3 ~ Φ10 (4 - 50 V)	250	5
	Φ4 ~ Φ10 (63 - 100 V)	250	5
	≥ Φ12.5	250	5

Lead Taping & Packaging

Case Size (mm)	Reel		
	D	H	W
	±0.2	±0.8	±1.0
4 x 5.4	380	21	14
5 x 5.4		21	14
6.3 x 5.4		21	18
6.3 x 7.7		21	18
8 x 6.2		21	18
8 x 10.2		21	26
10 x 10.2		21	26



Taping for Automatic Insertion Machines



Dimensions (mm)	W	A	B	P ₀	P ₁	P ₂	F	D ₀	E	t ₁	t ₂
Tolerance	Nominal	Nominal	Nominal	±0.1	±0.1	±0.1	Nominal	±0.1	Nominal	Nominal	Nominal
4 x 5.4	12	4.7	4.7	4	8	2	5.5	1.5	1.75	0.4	5.8
5 x 5.4	12	5.7	5.7	4	12	2	5.5	1.5	1.75	0.4	5.8
6.3 x 5.4	16	7	7	4	12	2	7.5	1.5	1.75	0.4	5.8
6.3 x 7.7	16	7	7	4	12	2	7.5	1.5	1.75	0.4	5.8
8 x 6.2	16	8.7	8.7	4	12	2	7.5	1.5	1.75	0.4	6.8
8 x 10.2	24	8.7	8.7	4	16	2	11.5	1.5	1.75	0.4	11
10 x 10.2	24	10.7	10.7	4	16	2	11.5	1.5	1.75	0.4	11
12.5 x 13.5	32	13.4	13.4	4	24	2	14.2	1.5	1.75	0.5	14
12.5 x 16	32	13.4	13.4	4	24	2	14.2	1.5	1.75	0.5	17.5
16 x 16.5	44	17.5	17.5	4	28	2	20.2	1.5	1.75	0.5	17.5

Construction Data

The manufacturing process begins with the anode foil being electrochemically etched to increase the surface area and then “formed” to produce the aluminum oxide layer. Both the anode and cathode foils are then interleaved with absorbent paper and wound into a cylinder. During the winding process, aluminum tabs are attached to each foil to provide the electrical contact.

The deck, complete with terminals, is attached to the tabs and then folded down to rest on top of the winding. The complete winding is impregnated with electrolyte before being housed in a suitable container, usually an aluminum can, and sealed. Throughout the process, all materials inside the housing must be maintained at the highest purity and be compatible with the electrolyte.

Each capacitor is aged and tested before being sleeved and packed. The purpose of aging is to repair any damage in the oxide layer and thus reduce the leakage current to a very low level. Aging is normally carried out at the rated temperature of the capacitor and is accomplished by applying voltage to the device while carefully controlling the supply current. The process may take several hours to complete.

Damage to the oxide layer can occur due to variety of reasons:

- Slitting of the anode foil after forming
- Attaching the tabs to the anode foil
- Minor mechanical damage caused during winding

A sample from each batch is taken by the quality department after completion of the production process. This sample size is controlled by the use of recognized sampling tables defined in BS 6001.

The following tests are applied and may be varied at the request of the customer. In this case the batch, or special procedure, will determine the course of action.

Electrical:

- Leakage current
- Capacitance
- ESR
- Impedance
- Tan Delta

Mechanical/Visual:

- Overall dimensions
- Torque test of mounting stud
- Print detail
- Box labels
- Packaging, including packed quantity



KEMET Electronic Corporation Sales Offices

For a complete list of our global sales offices, please visit www.kemet.com/sales.

Disclaimer

All product specifications, statements, information and data (collectively, the "Information") in this datasheet are subject to change. The customer is responsible for checking and verifying the extent to which the Information contained in this publication is applicable to an order at the time the order is placed.

All Information given herein is believed to be accurate and reliable, but it is presented without guarantee, warranty, or responsibility of any kind, expressed or implied.

Statements of suitability for certain applications are based on KEMET Electronics Corporation's ("KEMET") knowledge of typical operating conditions for such applications, but are not intended to constitute – and KEMET specifically disclaims – any warranty concerning suitability for a specific customer application or use. The Information is intended for use only by customers who have the requisite experience and capability to determine the correct products for their application. Any technical advice inferred from this Information or otherwise provided by KEMET with reference to the use of KEMET's products is given gratis, and KEMET assumes no obligation or liability for the advice given or results obtained.

Although KEMET designs and manufactures its products to the most stringent quality and safety standards, given the current state of the art, isolated component failures may still occur. Accordingly, customer applications which require a high degree of reliability or safety should employ suitable designs or other safeguards (such as installation of protective circuitry or redundancies) in order to ensure that the failure of an electrical component does not result in a risk of personal injury or property damage.

Although all product-related warnings, cautions and notes must be observed, the customer should not assume that all safety measures are indicated or that other measures may not be required.